

IDS-20d

Icing measurement system

Manual

Setup version 2.24 (Firmware 1.62)

18 May, 2020



Sommer Messtechnik

All rights reserved.

The Copyrights for this manual are exclusively owned by

Sommer Messtechnik
6842 Koblach
Austria

This manual or parts of it may only be copied or passed on to third parties with written permission of Sommer Messtechnik. This applies to printed as well as digital issues of this manual.



Sommer Messtechnik
Strassenhäuser 27
6842 Koblach
Austria
www.sommer.at
E office@sommer.at
T +43 5523 55989
F +43 5523 55989-19

Validity

This manual applies to the Icing measurement system with the setup version 2.24, including all its subversions.

Created: 31 Mar 2020

Last update: 18 May, 2020

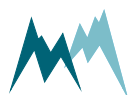

EU conformity



This product is in conformity with the following standards:

EMC	2014/30/EU	EN 301 489-1 V1.9.2
LVD	2014/35/EU	EN 62311:2008
		EN 62368-1:2014
RoHS II	2011/65/EU	
RoHS III	2015/863/EU	

Feedback

Should you come across any error in this manual, or if you miss information to handle and operate the IDS-20d we are very grateful for your feedback to office@sommer.at.

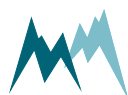

Safety information

Please read this manual carefully before installing or operating this equipment. Non-compliance with the instructions given in this manual can result in failure or damage of the equipment or may put people at risk by injuries through electrical or mechanic impact.

- Installation and electrical connections must be carried out by qualified personnel familiar with the applicable regulations and standards.
- Do not perform any installations in bad weather conditions, e.g. thunderstorms.
- Prior to installation of equipment inform the owner of the measurement site or the authority responsible for it. Upon completion, secure the installation from trespassers.
- Maintenance and repair must be performed by trained personnel or an engineer of Sommer Messtechnik. Only replacement parts supplied by Sommer Messtechnik should be used for repairs.
- Make sure that NO power is connected to the equipment during installation and wiring.
- Only use a power supply that complies with the power rating specified for this equipment.
- Keep equipment dry during wiring and maintenance.
- If applicable, it is recommended to use accessories of Sommer Messtechnik with this equipment.

Disposal



After this device has reached the end of its lifetime, it must not be disposed of with household waste! Instead, dispose of the device by returning it to a designated collection point for the recycling of waste electrical and electronic equipment.

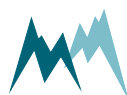

Content

1	What is the IDS-20d?	11
2	Unpacking	13
3	How do I start?	14
3.1	Connect the IDS-20d to a PC	14
3.2	Configure the sensor	15
3.3	Acquire measurements	16
4	Specifications	17
5	Connectors	19
5.1	Main	19
6	How does the IDS-20d work?	20
6.1	Sensors	20
6.1.1	Cube 1 sensor	20
6.1.2	Cube 5 sensor	21
6.1.3	Rod T 80 sensor	21
6.1.4	T/rH sensor	22
6.2	Controller	22
6.3	Plausibility check	22
6.4	Relay outputs	22
6.5	Data interpretation	22
7	Installation	27
7.1	Where should I install the IDS-20d?	27
7.2	What do I need?	27
7.3	How do I install the IDS-20d?	27
7.3.1	Mounting	27
7.3.2	Power supply	30
7.3.3	Signal cables	30
7.3.4	Lightning protection	30
8	Maintenance	31
9	Support software Commander	32
9.1	What can I do with it?	32
9.2	How do I install it?	32
9.2.1	System requirements	32
9.2.2	Installation procedure	32

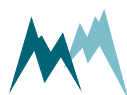

10	Configuration	38
10.1	Configuration with Commander support software	38
10.2	Configuration with a terminal program	40
10.3	What do I need to configure?	42
10.3.1	General settings	42
10.3.2	Sensor setup	43
10.3.3	Heater configuration	44
10.3.4	Icing verification	45
10.3.5	Relay switching	45
11	Serial communication	48
11.1	What are the options?	48
11.2	Which data do I get?	48
11.2.1	Main values	48
11.2.2	Special values	49
11.2.3	Analysis values	50
11.2.4	Exception values	51
11.3	RS-485	52
11.3.1	What is it?	52
11.3.2	What can I do with it?	52
11.3.3	How do I wire it?	52
11.3.4	How do I configure it?	53
11.3.5	How is the output structured?	55
11.3.6	Sommer protocol	55
11.3.7	Standard protocol	61
11.3.8	Which commands are available?	65
11.3.9	Sommer CRC-16	68
11.4	SDI-12	68
11.4.1	What is it?	68
11.4.2	What can I do with it?	68
11.4.3	How do I wire it?	68
11.4.4	How do I configure it?	69
11.4.5	How are commands structured?	70
11.4.6	Which commands are available?	70
11.5	Modbus	73
11.5.1	What is it?	73
11.5.2	What can I do with it?	74
11.5.3	How do I wire it?	74
11.5.4	How do I configure it?	74
11.5.5	How do I switch back to Sommer protocol?	79

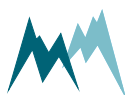

11.5.6	Which commands are available?	84
11.5.7	PLC integration	91
12	Parameter definitions	92
A	Relay A	92
A-A	Output value	92
A-B	Sensor choice	92
A-C	Turn off delay	92
A-D	Ice limit	93
A-E	Water limit	93
A-F	Ice rate limit	93
A-G	Test output	93
B	Relay B	93
B-A	Output value	94
B-B	Sensor choice	94
B-C	Turn off delay	94
B-D	Ice limit	94
B-E	Water limit	95
B-F	Ice rate limit	95
B-G	Test output	95
C	Sensor tests	95
C-A	Sensor S1, test heating	95
C-B	Sensor S1, test	95
D	Technics	95
D-A	Language/Sprache	96
D-B	Decimal character	96
D-C	SDI-12 address	96
D-D	Measurement Interval	97
D-E	Sensor S1	97
D-E-A	Sensor type	97
D-E-B	Sensor S1, orientation	97
D-E-C	Icing verification	98
D-E-C-A	Maximum temperature	98
D-E-C-B	Minimum humidity	98
D-E-C-C	Maximum water	98
D-E-C-D	Switch on delay	98
D-E-C-E	Temperature sensor choice	99
D-E-D	Limits and timer	99
D-E-D-A	Min. sup. voltage for heating	99
D-E-D-B	Ice, maximum	99



	D-E-D-C Ice, minimum	100
	D-E-D-D Water, maximum	100
	D-E-D-E Water, minimum	100
	D-E-D-F Ice rate, heating	100
	D-E-D-G Ice rate, minimum	101
	D-E-D-H Ice rate, holdtime	101
	D-E-D-I Maximum heating time	102
	D-E-D-J Subsequent heating, head	102
	D-E-D-K Subsequent heating, shaft	102
	D-E-D-L Cool down duration	102
	D-E-D-M Duration frost suppression	102
	D-E-D-N Meas. duration icing rate	103
D-E-E	Sensor S1 temperature	103
	D-E-E-A Temperature offset	103
	D-E-E-B Adjust temperature	104
	D-E-E-C Test temperature	104
D-E-F	Sensor S1, test heating	104
D-E-G	Sensor S1, zero adjust	104
D-E-H	Sensor S1, test	104
D-F	Sensor S2	104
	D-F-A Sensor type	104
	D-F-B Sensor S2, orientation	105
	D-F-C Icing verification	105
	D-F-C-A Maximum temperature	105
	D-F-C-B Minimum humidity	105
	D-F-C-C Maximum water	106
	D-F-C-D Switch on delay	106
	D-F-C-E Temperature sensor choice	106
D-F-D	Limits and timer	106
	D-F-D-A Min. sup. voltage for heating	107
	D-F-D-B Ice, maximum	107
	D-F-D-C Ice, minimum	107
	D-F-D-D Water, maximum	107
	D-F-D-E Water, minimum	107
	D-F-D-F Ice rate, heating	108
	D-F-D-G Ice rate, minimum	109
	D-F-D-H Ice rate, holdtime	109
	D-F-D-I Maximum heating time	109
	D-F-D-J Subsequent heating, head	109
	D-F-D-K Subsequent heating, shaft	109

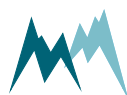

	D-F-D-L Cool down duration	109
	D-F-D-M Duration frost suppression	110
	D-F-D-N Meas. duration icing rate	110
D-F-E	Sensor S2 temperature	111
	D-F-E-A Temperature offset	111
	D-F-E-B Adjust temperature	111
	D-F-E-C Test temperature	111
D-F-F	Sensor S2, test heating	111
D-F-G	Sensor S2, zero adjust	111
D-F-H	Sensor S2, test	111
D-G	Temperature and humidity (TH)	111
	D-G-A Humidity offset	112
	D-G-B Adjust humidity	112
	D-G-C Test humidity	112
	D-G-D Temperature offset	112
	D-G-E Adjust temperature	112
	D-G-F Test temperature	113
D-H	Advanced settings	113
	D-H-A Sleep mode	113
	D-H-B SDI12 'M'-response	113
	D-H-C "OFF" turn off temperature	114
	D-H-D Functional switch monitoring	114
	D-H-E Functional switch at "OFF"	115
	D-H-F Sommer ID	115
D-I	RS-485 Protocol	115
	D-I-A Device number	116
	D-I-B System key	116
	D-I-C Output protocol (OP)	116
	D-I-D OP, measurement output	116
	D-I-E OP, information	117
	D-I-F OP, wake-up sequence	117
	D-I-G OP, prefix holdback	118
	D-I-H MODBUS, set default	118
	D-I-I MODBUS, device address	118
D-J	RS-485 Port	118
	D-J-A Baud rate	118
	D-J-B Parity, stop bits	119
	D-J-C Minimum response time	119
	D-J-D Transmitter warm-up time	119
	D-J-E Flow control	119

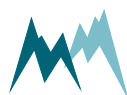

	D-J-F	Sending window	120
	D-J-G	Receiving window	120
	D-K	Units and decimals	120
	D-K-A	Temperature, unit	120
	D-K-B	Temperature, decimals	121
	D-L	Measurement table	121
E	Special functions		121
	E-A	Relay, reset counters	121
	E-B	Relay, simulate outputs	121
	E-C	Device status	122
	E-D	View setup	122
	E-E	Set factory default	122
	E-F	Temp. load factory default	122
	E-G	Relaunch program	122
	Appendix A	Measurement phases	123
	A.1	Sensor status	123
	A.2	Icing verification	123

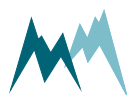

1 What is the IDS-20d?

During the winter season a lot of our infrastructure is affected by icing. In the transportation sector icing may not only impair the proper functioning of engines, sensors and signaling systems but may also pose serious hazards through icy runways and ice accretion on airplanes. Power generation by wind turbines solar- and hydroelectric generators may not be reliable under icy conditions and power transmission may be interrupted by heavy ice loads on power lines. Last but not least, ice on a building or other structure, e.g. antenna, may add a lot of weight and increase the surface area exposed to wind.

Reliable ice detection systems can help avoid such risks and can contribute to reduce maintenance and replacement costs. The ice detection sensor IDS-20d, in the shape of a cube or of rods, is used for the reliable and precise measurement of icing in aviation, on wind power generators, high voltage power lines, cable cars, antennas, overhead wires, roads, buildings and other structures where the formation of ice constitutes a risk.

Depending on the application the IDS-20d provides a combination of different sensor versions which can measure ice loads from 0.01 mm to 80 mm. By measuring the complex impedance in the vicinity of the sensor the IDS-20d is able to distinguish between water and ice and capable to record ice accretion rates.

A unique and valuable feature of the IDS-20d is that it additionally considers meteorological data for the purpose of a plausibility check: Parallel to the ice-sensor the IDS-20d measures the air temperature and humidity and thereof calculates the dew and frost points. The sensor system then uses these data for a plausibility check together of the measured ice values. Thus, the reliability of ice-detection is improved.

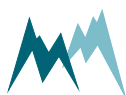

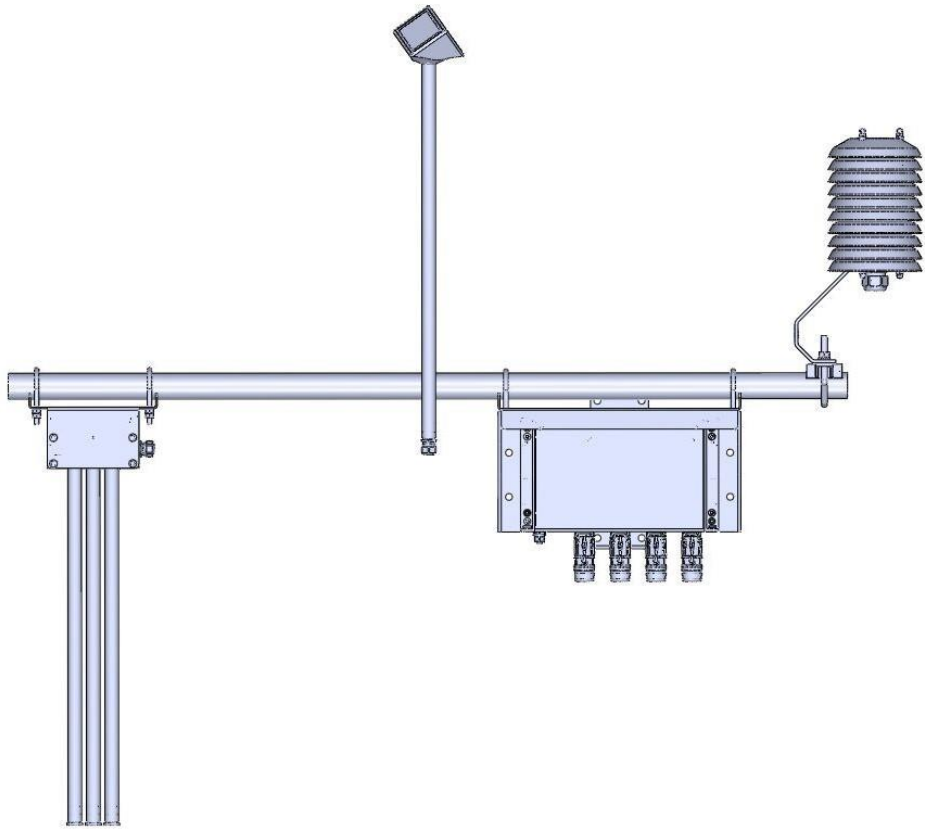

Figure 1 IDS-20d



2 Unpacking

When unpacking your IDS-20d sensor box please make sure that the following items are present:

Name
IDS-20d controller
Cube 5 ice sensor
Rod T sensor (optionally Cube 5 sensor)
Temperature and relative humidity probe
Radiation shield
Mounting pole \varnothing 34 x 800 mm
Mounting brackets for controller, sensors and radiation shield
MAIN sensor cable
USB to RS485 isolated converter cable
Manual and Commander Software on USB stick

In case of missing or damaged items please contact your Sommer sales partner.

Available accessories

Art	Accessory
20557	Heating transformer 230/24V, 160VA, IP00
20519	IDS-20 Main-cable 10 m
21150	USB to RS485 isolated converter cable



3 How do I start?

Follow the steps described below to set the basic configurations and to acquire the first measurement results.



NOTE Perform the first start-up in your lab or office before installing the equipment in the field!

3.1 Connect the IDS-20d to a PC

1. Install the Commander support software (see [How do I install it?](#))
2. Connect the yellow and gray wire of the sensor cable to the USB to RS485 isolated converter cable and plug it into your PC as illustrated in the figure below.
3. Connect a 10...28 VDC power supply to the IDS-20d
4. Start the Commander software.
5. Click on **Communication assistant** on the right-hand side of the Commander window and follow the instructions. During this procedure the communication assistant will search for connected devices. Upon successful completion, the new connection is added to the connections list (tab **Connections (F8)**).
6. In the **Communication** Section at the right-hand side of the Commander window select Mode **Connection** and the previously created connection from the drop-down list.
7. Click **Connect** to establish a connection with the IDS-20d. If the connection was successful a green icon is displayed at the top-right corner of the Commander window.
8. Select the tab **Parameters (F2)** and click **Download parameters from device** on the left side of the Commander-window. The complete parameter list is transferred from the sensor to your PC and displayed in the **Parameter** window.

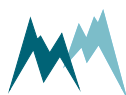

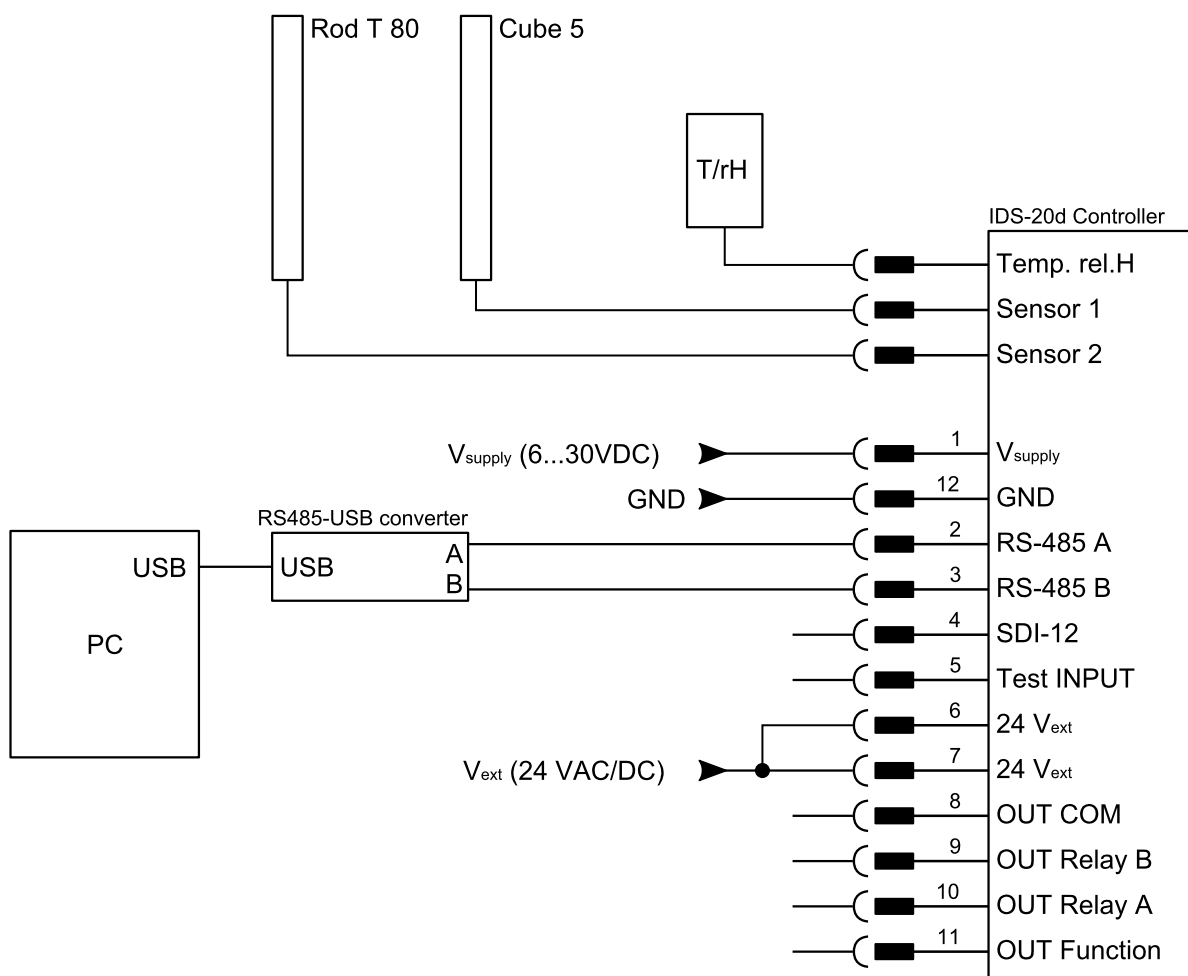

Figure 2 Wiring of the IDS-20d to a PC

3.2 Configure the sensor

1. Select language, units and decimal character (see [General settings](#))
2. Define the scope and structure of the data output (see [General settings](#))
3. Define the orientation of the sensor (see [Sensor setup](#))
4. Set the zero-reading of the sensor (see [Sensor setup](#))
5. Set the limits at which the relays switch (see [Relay switching](#))
6. Send any modifications to the IDS-20d by clicking [Upload modified parameters to device](#).

Upon successful configuration the IDS-20d may be connected to a data acquisition system for continuous ice monitoring.

3.3 Acquire measurements

Select the tab **Measurement (F3)** and click **Start polling measurements**. Select **Polling with measurements** and confirm the Warning. Now, the device performs consecutive measurements at the fastest possible rate. Click **Stop polling** to cancel data acquisition.

Commander 1.0.8.10

File | Tabs | Options | Extra | Help

Parameters (F2) | **Measurement (F3)** | Data (F4) | Profile (F6) | Stations (F7) | Connections (F8) | Terminal (F9)

Information

Device: SQ-Xa
Protocol address: 0001
Parameter: From file
File name: retour Kunde-Auslieferungsparam
Serial number: 24190325
Setup version: 2.39.03
Software: 0001

Devices

SQ-Xa
0001

Self-check

Code	Description	Cause	Solution
0	Sensor operates normally	-	-

Measurement values

ID	Name	Value	Unit
0	Self-check	0	
1	Level	49	mm
2	Velocity	1.003	m/s
3	Quality (SNR)	67.05	
4	Flow	5.143	m ³ /h
5	Flow sum		m ³
6	Learned velocity	1.003	m/s
7	Learned flow	5.143	m ³ /h

Measurement data graph

Flow [m³/h]

2020-03-03 10:05:00 | 2020-03-03 10:10:00

Commands

Start and stop polling

Last measurement

Authorization: Expert

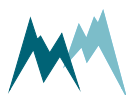

4 Specifications

IDS-sensors			
Sensor type	Cube sensor 5	Cube sensor 1	Rod sensor 80
Measuring range ice thickness	0.1...5 mm	0.01...1 mm	1...80 mm
Weight	0.7 kg	0.7 kg	2.3 kg
Length	560 mm	560 mm	580 mm

T/rH-sensor	
Dew point	-20...+20 °C
Frost point	-20...+20 °C
Air temperature	-40...+60 °C
Air humidity	0...100 %
Weight	0.715 kg
Size L x W x H	310 x 120 x 165

IDS-controller	
Power supply	Sensors 10...28 VDC Heating 24 VAC/DC integrated overvoltage protection
Power consumption	Active measurement 50 mA at 12 VDC Heating max. 7A at 24 VAC/DC
Output	RS-485 (Modbus) SDI-12 3x relay output, max. 0.8 A each
Operating temperature	-40...60 °C
Protection rating	IP 66



IDS-controller

Lightning protection	Integrated Lightning Protection against indirect Lightning; discharge capacity 0,6 kW Ppp
Size L x W x H	318 x 208 x 132 mm
Weight	3.6 kg

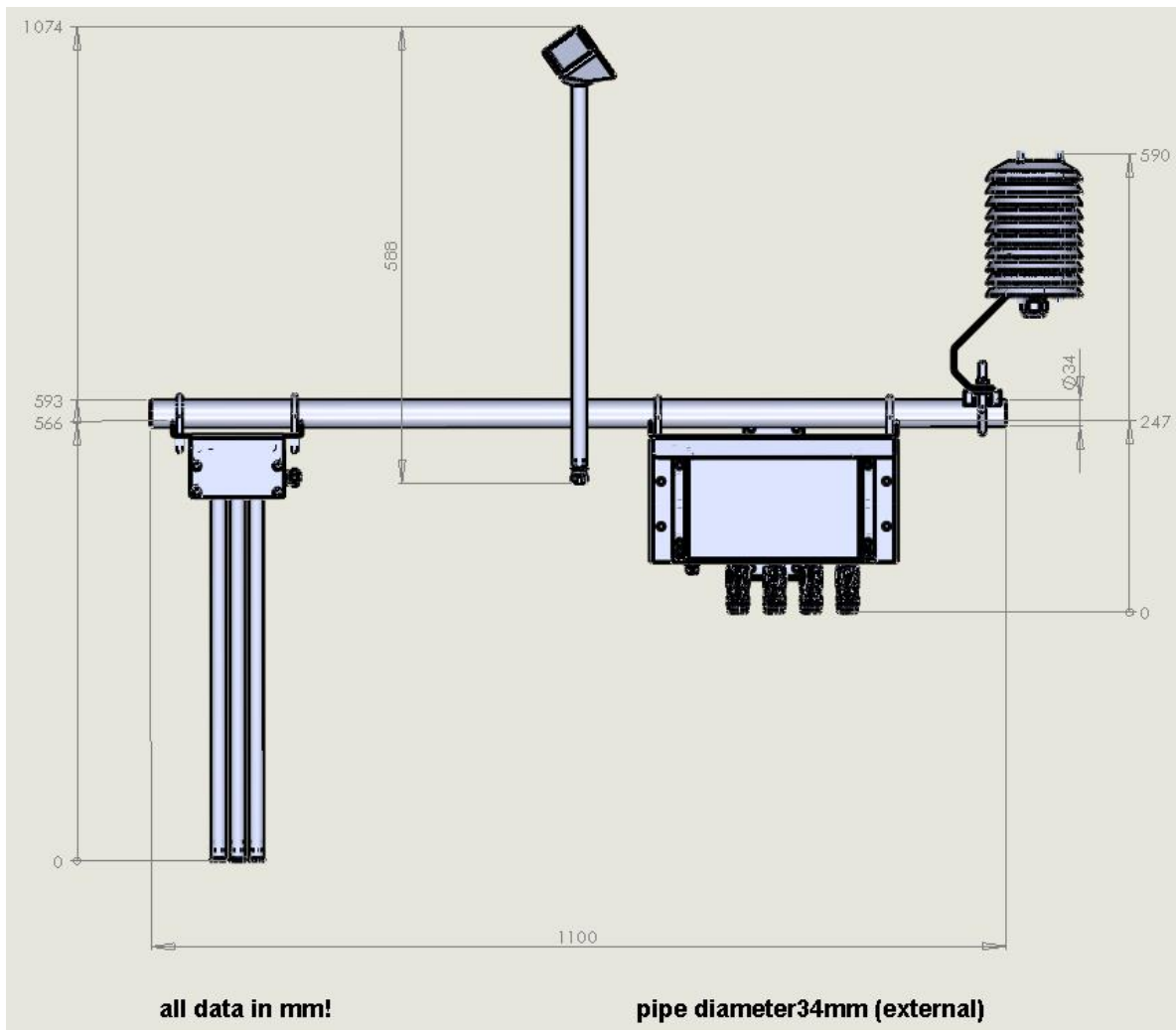

Figure 3 IDS-20d dimensions

5 Connectors

5.1 Main

MAIN (12 Pins)	Pin/Wire	Function	Description
Power supply	1	Vsupply	10...30 V
	12	GND	yellow-green
RS-485 interface	2	RS485 A	1 x RS-485 (1200...115200 Baud) ASCII – Protokoll Modbus
	3	RS485 B	
SDI-12 interface	4	SDI12	1 x SDI-12 (1200 Baud)
Test-INPUT (Simulation)	5	Test	Low Level: 0...0,6 V High Level: 2...30 V
Heating	6	24V _{ext}	AC or DC
	7	24V _{ext}	AC or DC
Relay OUTPUT	8	OUT COM	potential-free, max. 0.8A
	9	OUT Relay B	
	10	OUT Relay A	
	11	OUT function	



ATTENTION The relay outputs are referenced to GND on pin 12.

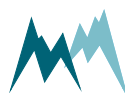

6 How does the IDS-20d work?

The IDS-20d ice sensor makes use of the different physical characteristics of air, water and ice at varying frequencies of an applied voltage. As illustrated in [Figure 4](#) a single ice-sensor consists of two conductive paths which generate an electric field between them when powered. This electric field is different for air, water and ice. By measuring the resulting complex impedance at different frequencies the volume content of ice, water and air can be detected.

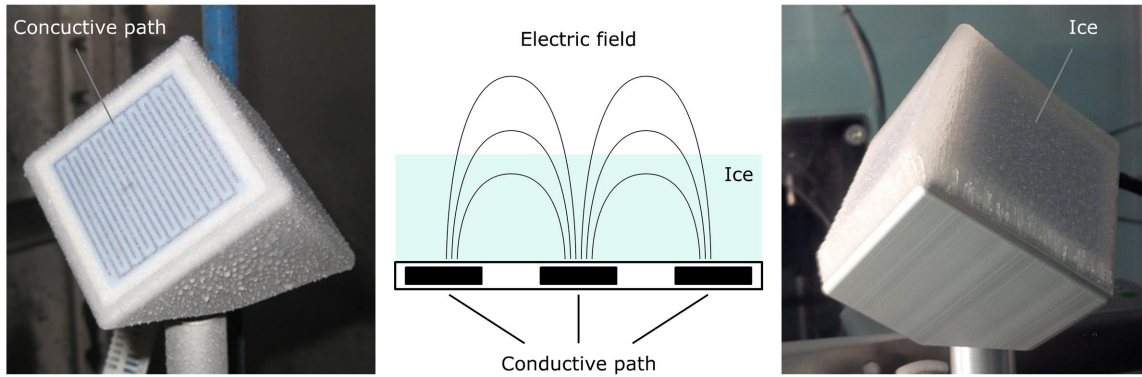

Figure 4 Principle of ice detection

6.1 Sensors

Depending on the application the IDS-20d is available in three versions with different sensor combinations. [Figure 5](#) illustrates these versions.

The IDS-20s contains a single ice-sensor, either the Cube 5 or the Rod T 80. While the first option is primarily used to detect icing events, the latter is applied to monitor heavy ice loads.

The IDS-20a combines two Cube 1 sensors and is mainly applied in aviation. As these two sensors operate intermittently icing events can be detected without any interruption.

The IDS-20dd combines a Cube 5 and Rod T 80 sensor. This versatile system can detect icing events and heavy ice loads and is usually applied in monitoring of buildings and other structures, e.g. antennas or power lines.

6.1.1 Cube 1 sensor

The Cube 1 sensor contains three sensor plates arranged in an angle of 120° to each other. This arrangement allows the determination of the icing direction. The sensor plates can detect water, freezing rain and ice accretion from 0.01 to 1 mm.

The sensor head contains a Pt1000 sensor to monitor the surface temperature of the device. Sensor head and shaft can be heated separately with a 24 VAC/DC power supply.

6.1.2 Cube 5 sensor

The Cube 5 sensor contains three sensor plates arranged in an angle of 120° to each other. This arrangement allows the determination of the icing direction. The sensor plates can detect water, freezing rain and ice accretion from 0.1 to 5 mm.

The sensor head contains a Pt1000 sensor to monitor the surface temperature of the device. Sensor head and shaft can be heated separately with a 24 VAC/DC power supply.

IDS-20s with Cube5 sensor

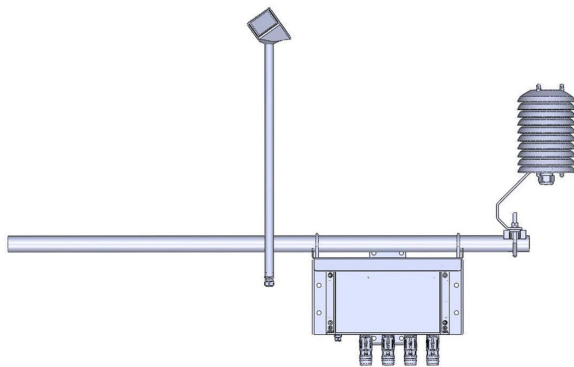

IDS-20s with rod T 80 sensor

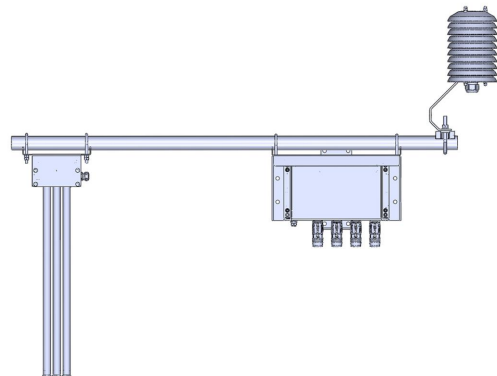

IDS-20c with Cube 1 and Cube 5 sensor

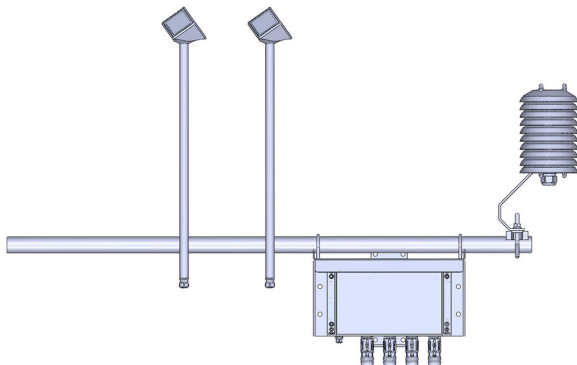

IDS-20d with Cube 5 and rod T 80 sensor

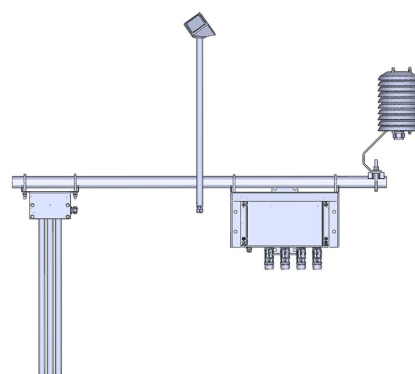

Figure 5 IDS-20d versions

6.1.3 Rod T 80 sensor

The Rod T 80 sensor consists of three metal rods arranged in a triangle. The sensor can detect water, freezing rain and ice accretion from 1 to 80 mm.

The sensor head contains a Pt1000 sensor to monitor the surface temperature of the device. The sensor does not contain a heating option.

6.1.4 T/rH sensor

To validate the icing detected by the ice-sensors an additional T/rH-probe is mounted with the system. See [Plausibility check](#) for details.

6.2 Controller

The ice- and T/rH-sensors are connected to the controller of the IDS-20d which reads and processes the acquired data and controls the sensor heating. It also provides an interface to connect to a data processing device, e.g. PC or data logger, and a power supply.

6.3 Plausibility check

Formation and accretion of ice on a surface depends on specific environmental conditions determined by air temperature, humidity and surface temperature.

The IDS-20d uses the present meteorological conditions to verify the icing measured by the ice-sensors: Parallel to the ice detection the IDS-20d measures the air temperature and humidity and calculates the dew and frost points. With these data the IDS-20d checks if the conditions actually permit the formation of ice as detected by the ice-sensors. Thus, icing events are detected with high reliability.

6.4 Relay outputs

The IDS-20d provides two relay outputs to record the occurrence of icing events or to trigger an action upon ice detection. Both relays can be configured to switch at a specified ice or water layer thickness or icing rate. By doing so, different switching combinations can be selected:

- relay A and B respond to limit values of one sensor, e.g. ice layer thickness and icing rate
- relay A responds to a limit value of sensor 1, e.g. presence of water, and relay B to a limit value of sensor 2, e.g. icing rate
- one relay responds to a limit value of one sensor, e.g. icing rate, and the other is turned off

The IDS-20d contains an additional relay that responds to the state of the device, i.e. switches if the IDS-20d detects an error. The relay output can be configured to either close on proper functioning of the device or if the device detects an error.

6.5 Data interpretation

Ice forms at certain air and surface temperatures under high humidity levels. In many applications the information of instantaneous icing on a surface is required. In others, the duration and

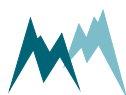

intensity of an icing event is of interest. In the following examples the interaction between atmospheric conditions and the occurrence of icing is illustrated.

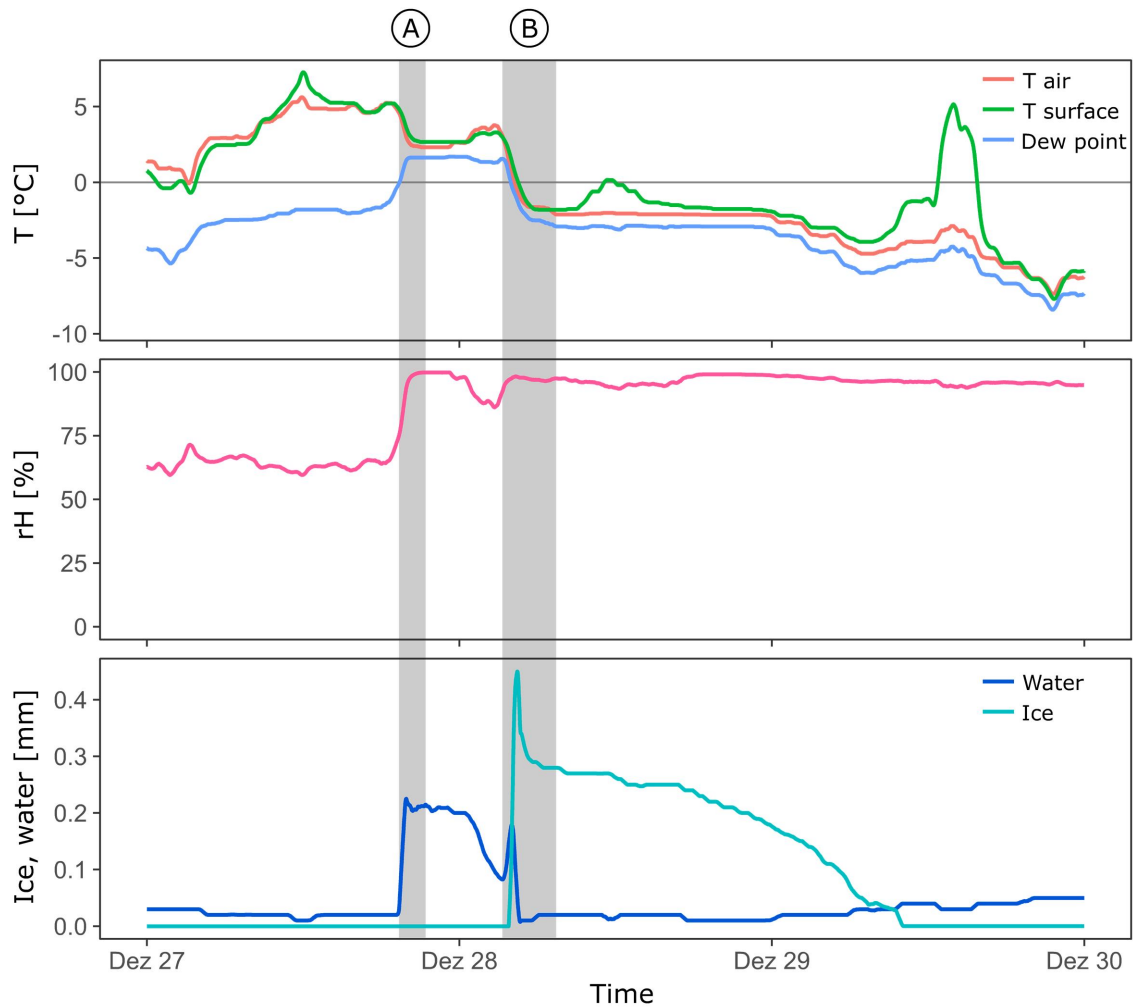

Figure 6 Dew and ice on a Cube 5 sensor

In Figure 6 the formation of water and ice on a Cube 5 sensor is shown. In period A the air and surface temperature of the sensor drop and closely reach the dew point, thus increasing the relative humidity. As a consequence water condenses on the sensor surface as illustrated in the lower plot.

During the early morning hours the air and surface temperature further drop below freezing. This temperature drop first leads to more water condensation and is then followed by a sharp rise in ice formation as the water freezes. Shortly after, the sun rises and transforms the thin ice layer on the sensor through irradiation. This is visible by a quick drop of the ice thickness. During the day more ice sublimates despite below-zero temperatures.

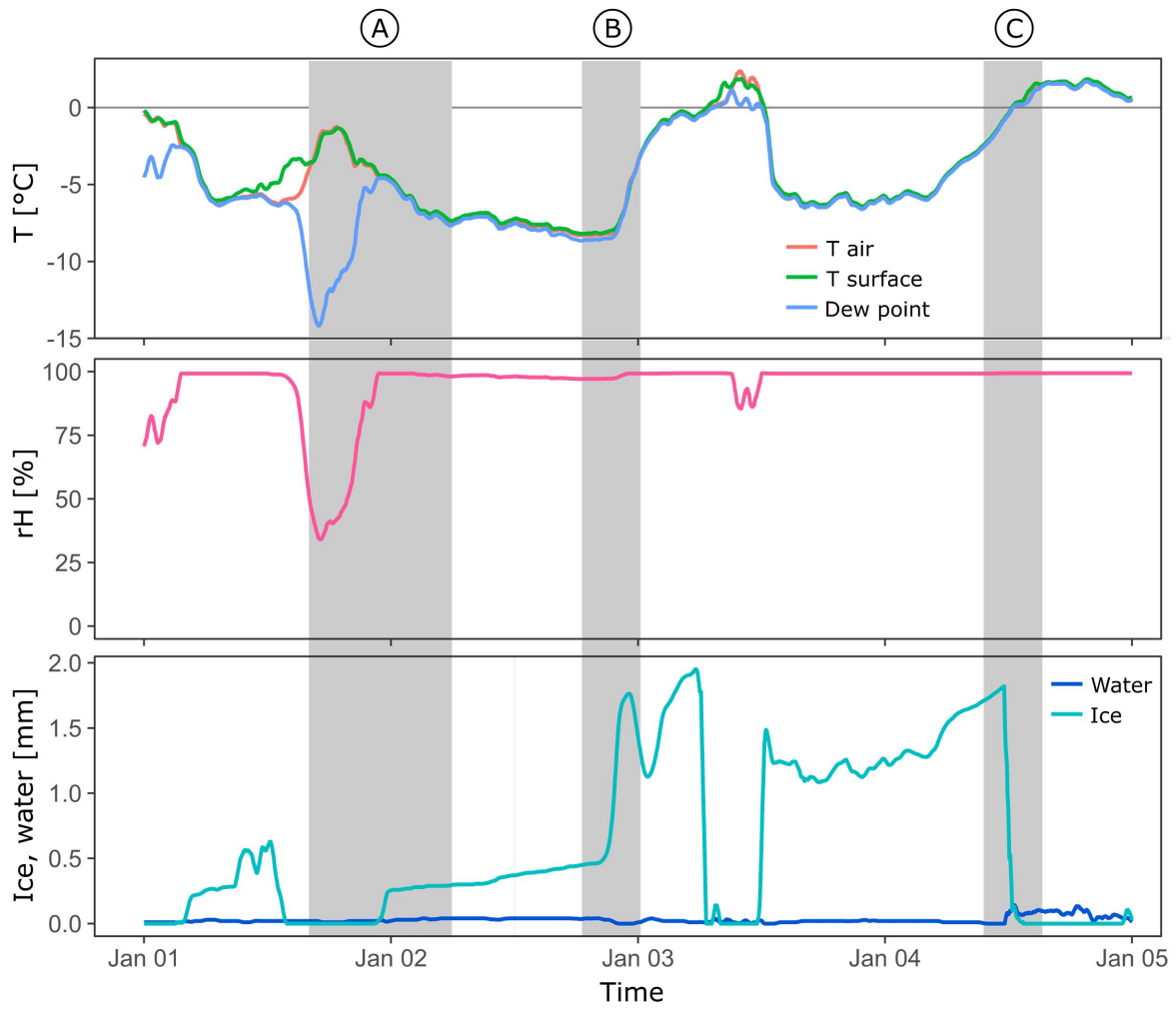
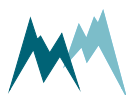

Figure 7 Icing of a Cube 5 sensor

In Figure 7 several icing events of a Cube 5 sensor are illustrated. During period A air and sensor surface temperature are below zero. However, due to relatively dry air no ice is formed on the sensor. Later on, as the temperature drops again, the humidity approaches saturation. As soon as the frost point is reached, ice starts to accrete on the sensor surface and keeps doing so with further falling temperatures.

During period B the temperature reaches a minimum and then rises within a few hours by more than 5°C. Consequently, the ice layer on the sensor grows considerably faster.

In period C the temperature rises from below zero to positive temperatures, keeping its water saturation. Once the temperature passes 0°C the ice on the sensor melts rapidly, which is marked by a sharp drop in ice layer thickness and a slight increase of water on the surface.



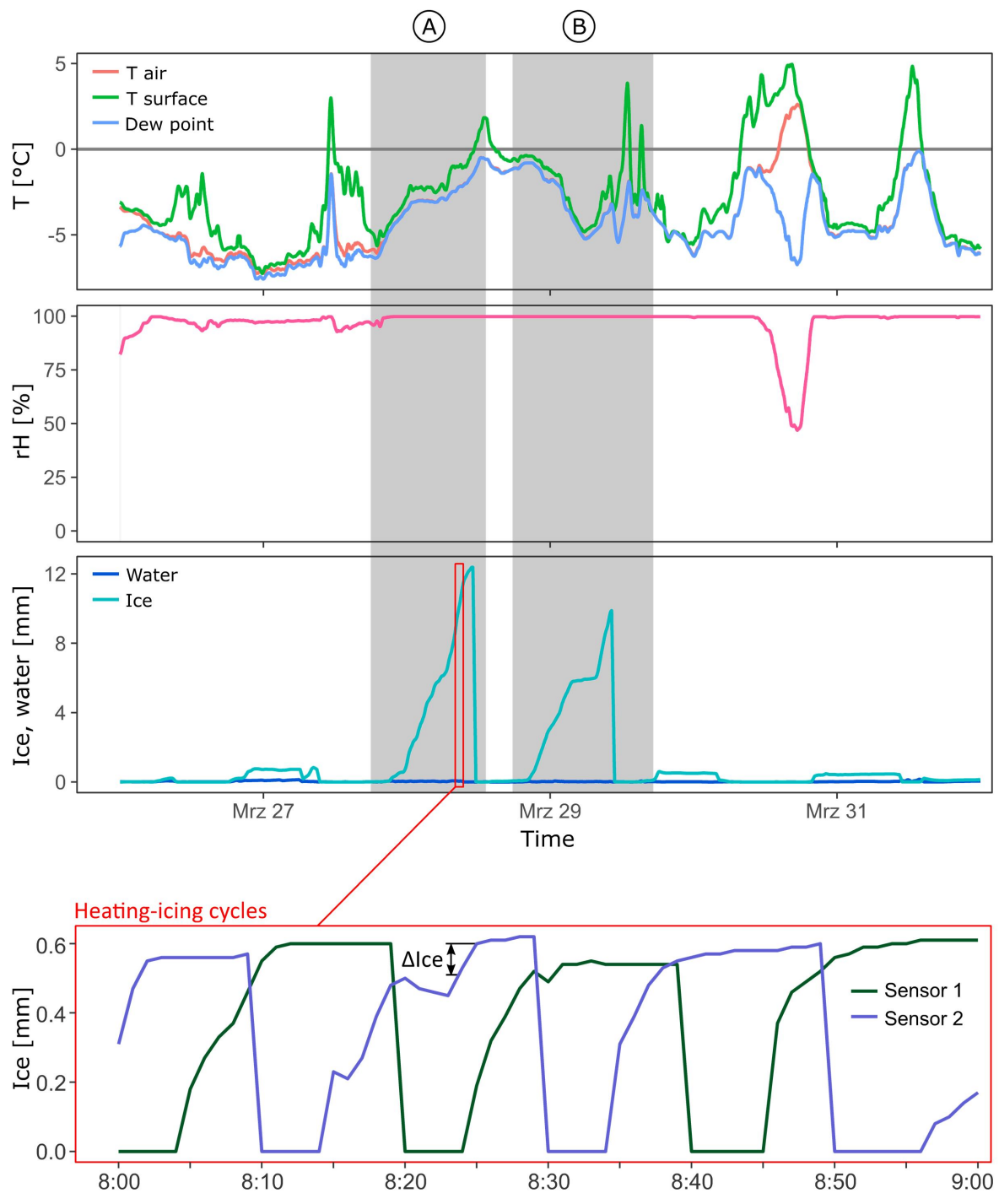
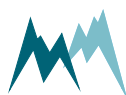

Figure 8 Icing-heating cycle of a Cube 1 sensor pair

In Figure 8 two pronounced icing events are shown. The ice layer on the sensor surface grows at different rates, depending on the ambient temperature. As soon as the sensor surface temperatures rise above 0°C again the ice on the Cube 1 sensors melts rapidly and thus terminates the icing events.



The close-up of [Figure 8](#) also shows the intermittent heating-icing cycles of the two Cube 1 sensors used in the IDS-20a. Whenever one sensor is heated and dried, the other monitors ice accretion. The ice accumulation between two measurements, Δ_{ice} , is summed up and recorded as the total ice thickness as shown in the Ice graph above.



7 Installation

7.1 Where should I install the IDS-20d?

The IDS-20d may be installed as a stand-alone system or mounted to facilities such as wind turbines, utility poles or antennas. To gain icing data that describe the icing on the monitored facility as accurate as possible the IDS-20d has to be installed at a representative position. This means that the ice-sensors should face the same environmental conditions as the monitored facility. Especially, the ice-sensors should not be mounted in the lee of an installation. It is also very important that the ice-sensors are influenced as little as possible by any installation or structure. Make sure that the sensors are not installed too close to your monitored facility.

The sensors and controller of the IDS-20d have very low power consumption and can be operated with an autonomous power supply, e.g. solar generator. However, if the IDS-20d is operated with sensor heating (up to 7 A at 24 VAC/DC) your measurement site needs to have access to mains power.

The IDS-20d must not be installed where passers-by could be hit by falling ice. If required, close off the measurement site and/or indicate the risk.

7.2 What do I need?

Prepare the following equipment and tools to install the IDS-20d:

- Flat spanner 13 mm
- Side cutter

7.3 How do I install the IDS-20d?

7.3.1 Mounting

The IDS-20d is shipped with mounting accessories which combine the ice-sensors, T/rH-sensor and the controller to a single unit. Please follow the instructions below to mount your IDS-20d:

1. Mount the IDS-20d controller to the structure of your measurement site with the provided shackles. The housing of the IDS-20d controller provides brackets to mount a horizontal or vertical tube with a diameter up to 60 mm. Tighten the shackles around the tube and secure them with additional nuts.
2. Attach the supplied \varnothing 34 mm mounting tube to the IDS-20d controller as illustrated in [Figure 9](#). Tighten the shackles around the tube and secure them with additional nuts.

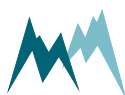

3. Mount the Cube 5 sensor on the 34-mm tube with the black dot on the sensor head facing north. Make sure that the sensor is mounted upright. Tighten the shackles around the tube and sensor shaft and secure them with additional nuts. If the sensor is not adjusted towards north, any offset can be corrected for in the Commander software.
4. Attach the Rod T 80 sensor on the 34-mm tube with the black dot on the sensor head facing north. Make sure the rods of the sensor point downwards. Again, tighten the shackles around the tube and secure them with additional nuts. If the sensor is not adjusted towards north, any offset can be corrected for in the Commander software.

**ATTENTION**

The rods of the Rod T 80 sensor must always point downwards. Otherwise, ice may accrete on the sensor housing and thus produce erroneous ice readings.

However, the Rod T 80 sensor may be mounted in a slanted position as shown in 7.3.1. This might be appropriate when monitoring power lines. In this case the sensor may be aligned in the direction of the power cables.

5. Insert the T/rH-sensor into the radiation shield and secure it by tightening the plastic nut.
6. Attach the radiation shield in an upright position to the 34-mm tube. Tighten the shackles around the tube and secure them with additional nuts.
7. Connect the sensor cables to the quick-connectors of the IDS-20d controller:
 1. Cube 5 sensor to Sensor 1
 2. Rod T 80 sensor to Sensor 2
 3. T/rH-sensor to Temp. rel. H
8. Connect the MAIN sensor cable to the IDS-20d controller.
9. For the sensor heating and controller operation connect your power supply to the other end of the MAIN sensor cable as shown in Figure 2. Separate power supplies for controller and heating may be used. Make sure the power supply for the sensor heating provides sufficient power for defrosting ($\leq 7A$).
10. Connect your data acquisition device to the IDS-20d.
11. Optional: Connect the IDS-20d controller to the switch cabinet provided as an accessory by Sommer.



TIP Sommer provides a switch cabinet for the IDS-20d. This cabinet contains a power supply for sensor heating and controller operation, a data logger as well as a cellular modem for data transmission.

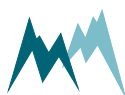

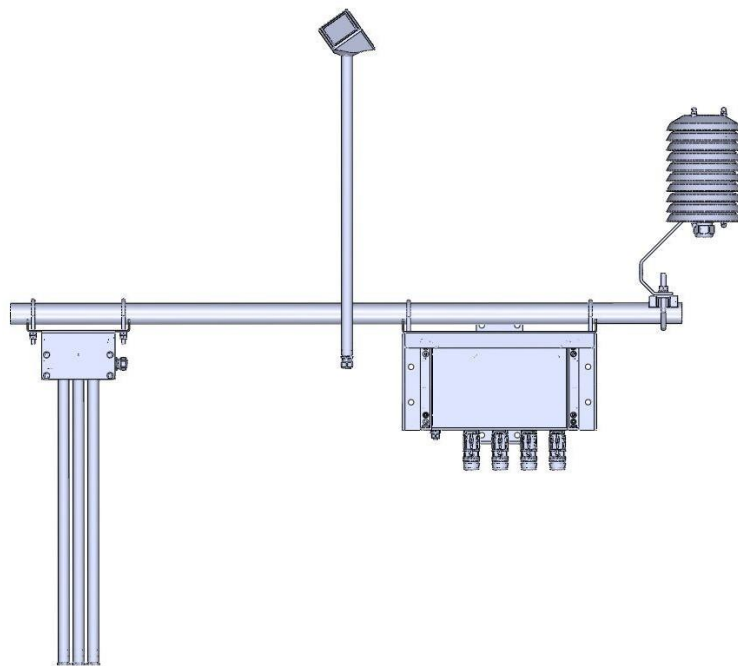

Figure 9 Sensor and controller mounting

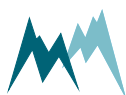
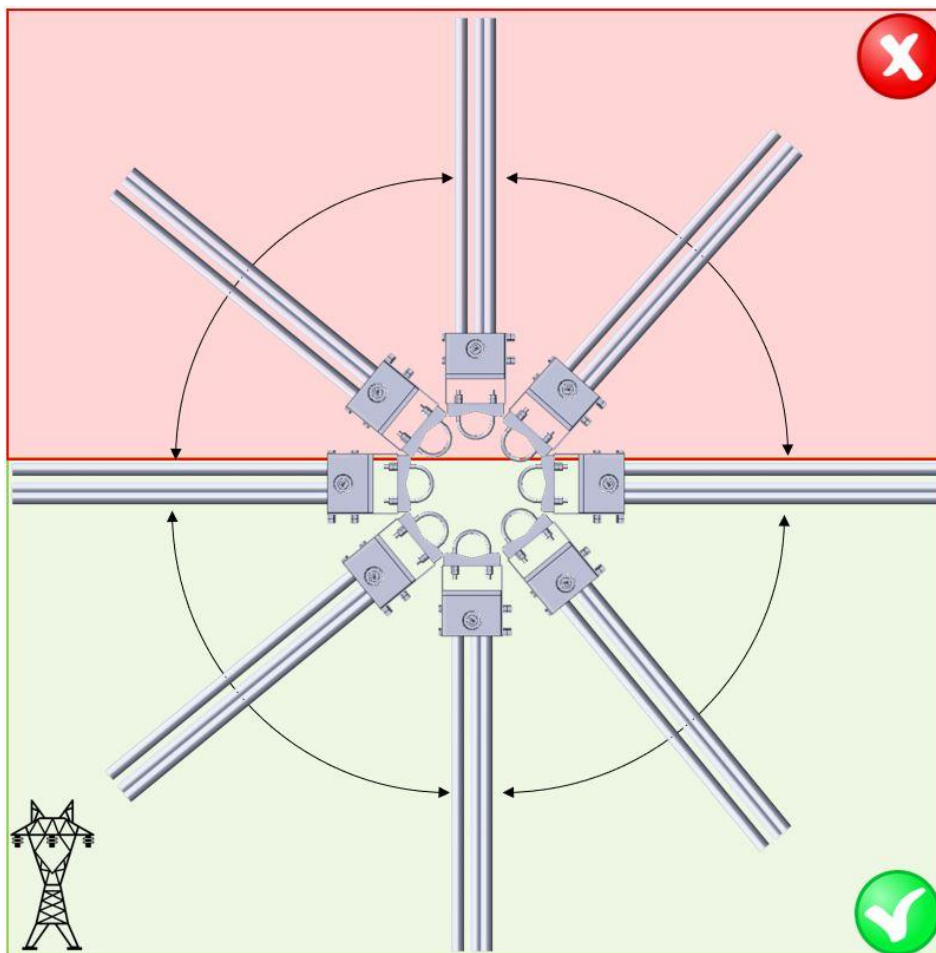

Figure 10 Mounting of Rod T 80 sensor

7.3.2 Power supply

The IDS-20d consumes 50 mA @ 12 V during active measurements. Between measurements the IDS-20d automatically switches into standby-mode.

The Cube 5 sensor of the IDS-20d is heated if a defined ice-layer thickness is exceeded. This heating requires up to 7A @ 24V and can be provided by either a 24 VAC or 24 VDC power supply. The Rod T 80 sensor has no heating.

7.3.3 Signal cables

Please consider the maximum cable lengths for the applied transmission protocol:

Protocol	Max. cable length [m]
SDI-12	60
RS-485	300

Table 1: Maximum cable lengths



NOTE Cable lengths longer than 60 m require a heavier gauge wire if the power supply drops below 11 V.

7.3.4 Lightning protection

If the underground at the measurement site permits sufficient current dissipation it is strongly recommended to equip the sensor support or mast with properly dimensioned lightning protection. Consult an expert for advice.

The IDS-20d is protected against overvoltage. If a data logger is mounted to the mast, its ground lug must be properly connected to earth ground.

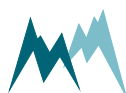

8 Maintenance

The IDS-20d generally does not require any special maintenance. However, the ice-monitoring system should be inspected regularly for any damage or soiling on the Cube 5 sensor and any dirt on the tip of the T/rH-sensor. If required, the sensor head and rods can be cleaned with water.

It is recommended to compare the temperature measurements of the ice-sensors and the T/rH-sensor regularly. Any offset can be corrected in the IDS-20d setup section [Technics](#). If the temperature offset should be too large, a sensor recalibration is recommended.

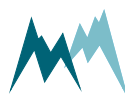

9 Support software Commander

9.1 What can I do with it?

The Commander is a multipurpose software tool to configure and operate any Sommer Messtechnik device. It offers the following functions:

- Communication with Sommer Messtechnik sensors and data loggers via serial connection, modem, socket, IP-call and Bluetooth®
- Management of connections and stations
- Configurations of sensors and data loggers
- Live data monitoring and storage
- Data management including download from data loggers and transmission to MDS (Measurement Data server)
- Terminal window to check data transfer and to access device settings directly
- Spectrum-Mode to visualize radar and ultrasonic spectra (used for diagnostic purposes, e.g., multiple reflections)

9.2 How do I install it?

9.2.1 System requirements

The Commander software supports 32- and 64-bit versions of Windows 7 SP1, Windows 8, Windows 8.1 and Windows 10.

For correct operation Microsoft® .NET Framework 4.5 or later must be installed.

9.2.2 Installation procedure

Follow the steps below to install the Commander software:

1. Plug the USB stick shipped with the device into your PC.
2. Double-click the [commander.msi](#) installer file on the USB drive.
3. Click [Next](#) on the pop-up window

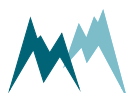



4. Read the instructions and click [Next](#)

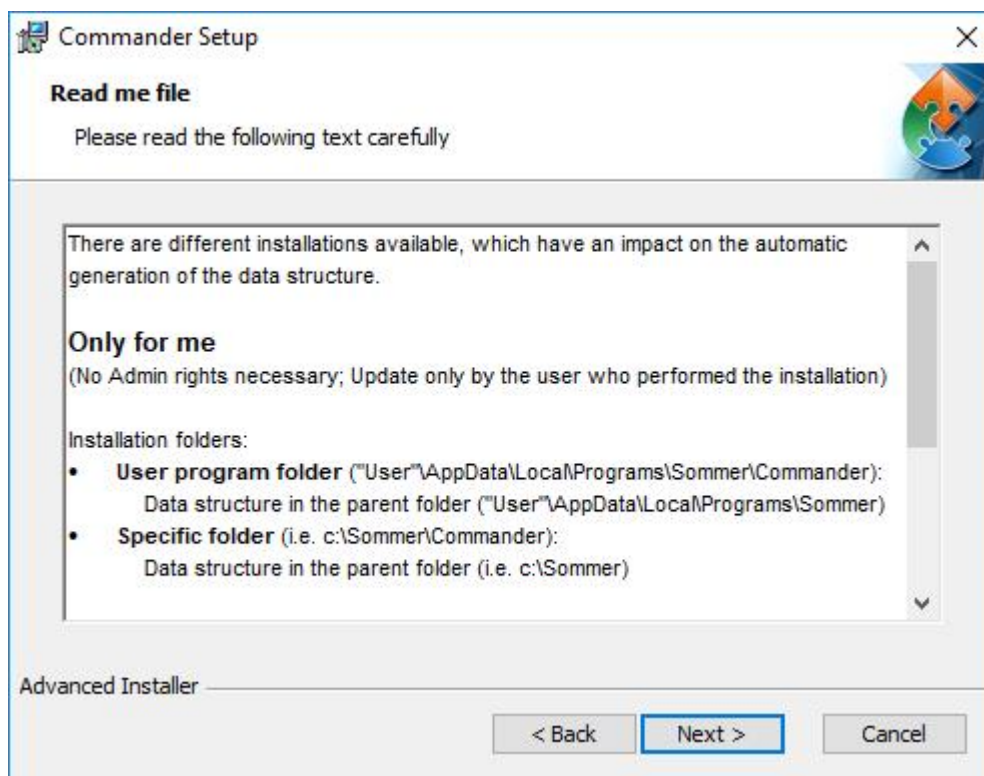

5. Select the installation type and click [Next](#)



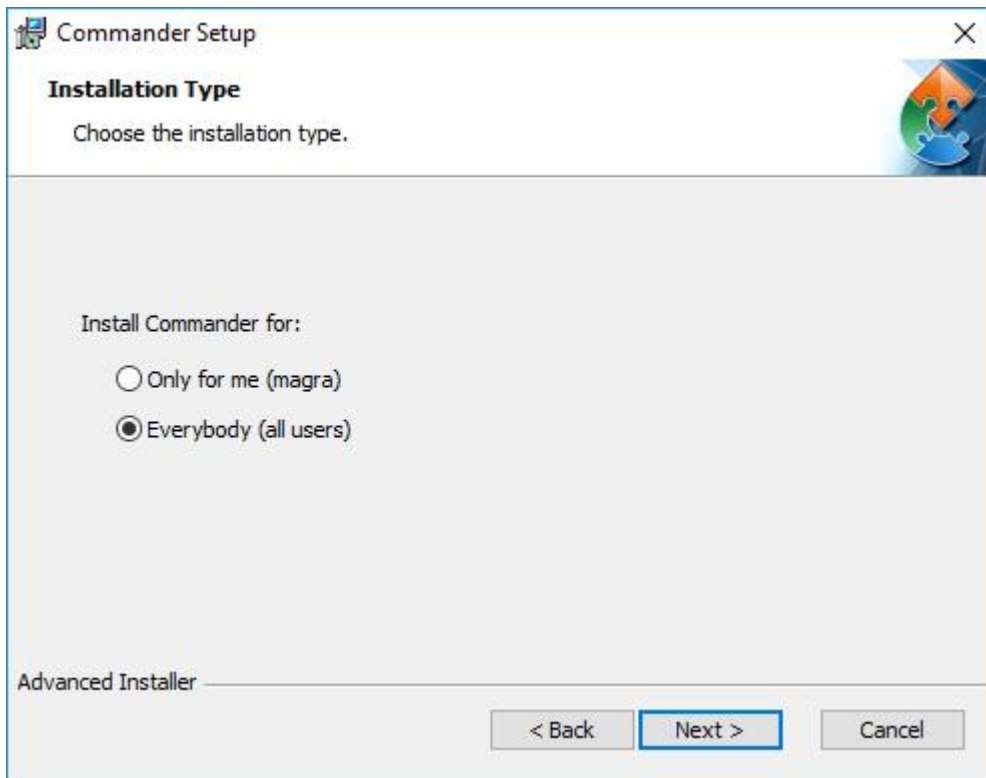

NOTE

Two installation types are available. Depending on the selection, the access rights and the folder structure differ:

Only for me

No admin rights are required. Updates are only available to the user who installed the software.

Installation folders:

- User program folder:
Users\User\AppData\Local\Programs\Sommer\Commander
Data structure:
Users\User\AppData\Local\Programs\Sommer
- Specific folder (default):
C:\Sommer\Commander
Data structure (default):
C:\Sommer

Everybody

Admin rights are required. Updates may only be performed by system administrators.

Installation folders:

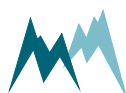



- Standard program folder:
Program Files (x86)\Sommer\Commander
Data structure:
Users\Public\Public documents\Sommer
- Specific folder (default):
C:\Sommer\Commander
Data structure (default):
C:\Sommer

6. Select the installation directory and click **Next**.

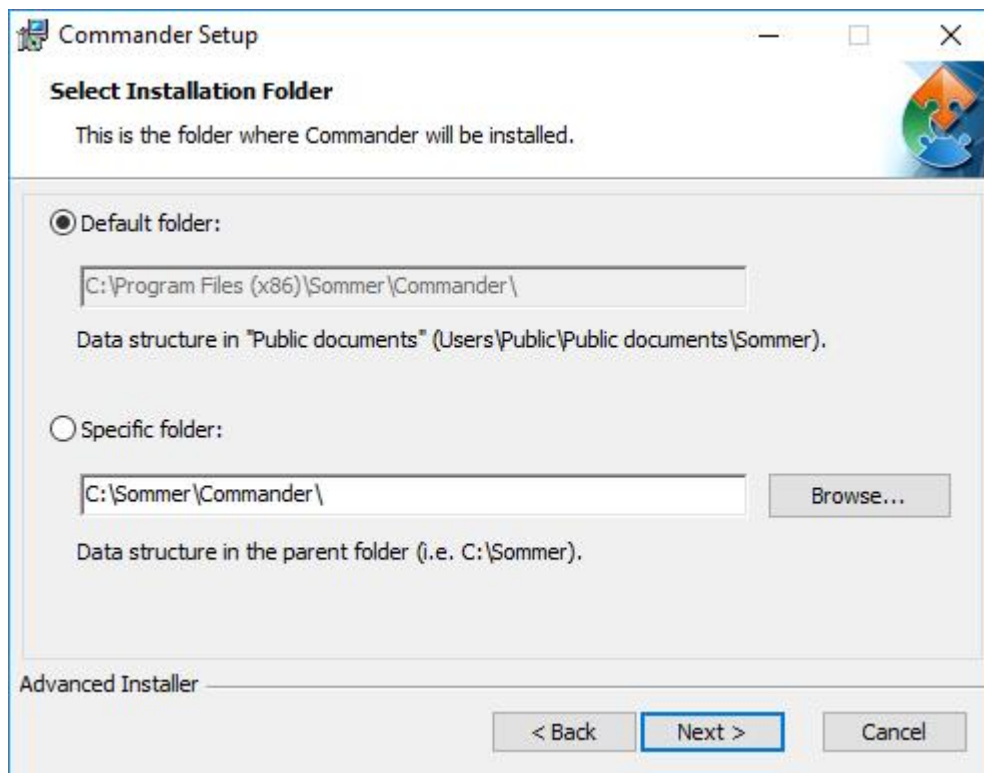

7. Select the features to be installed and click **Next**.

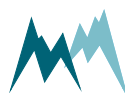

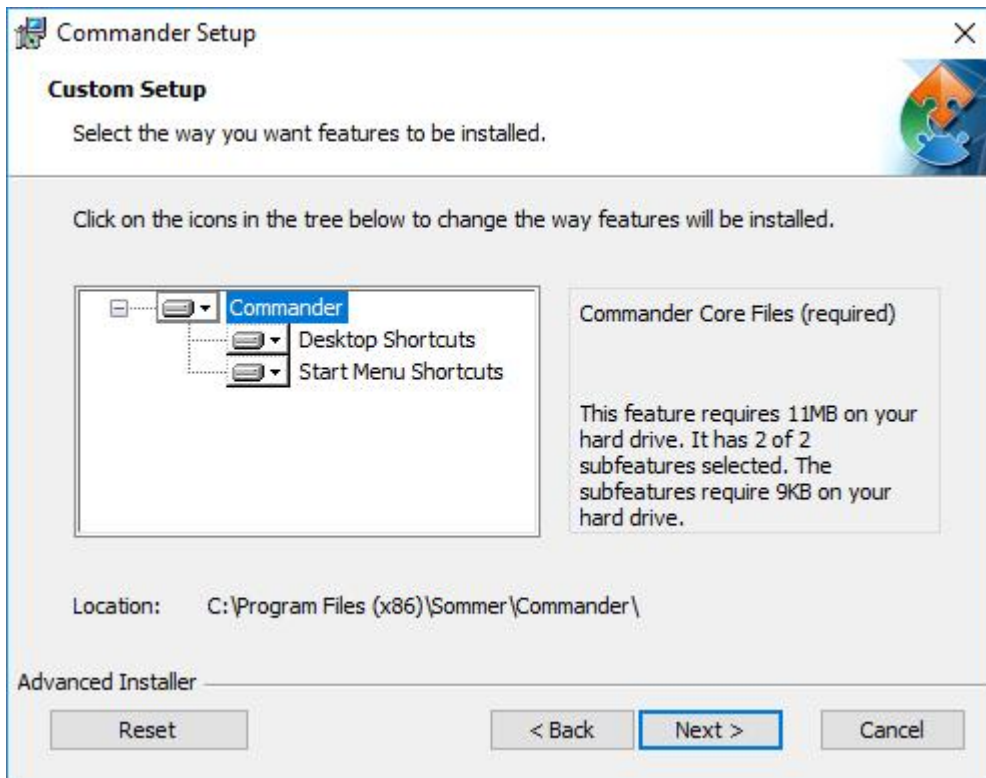

8. Click **Install** to start the installation.

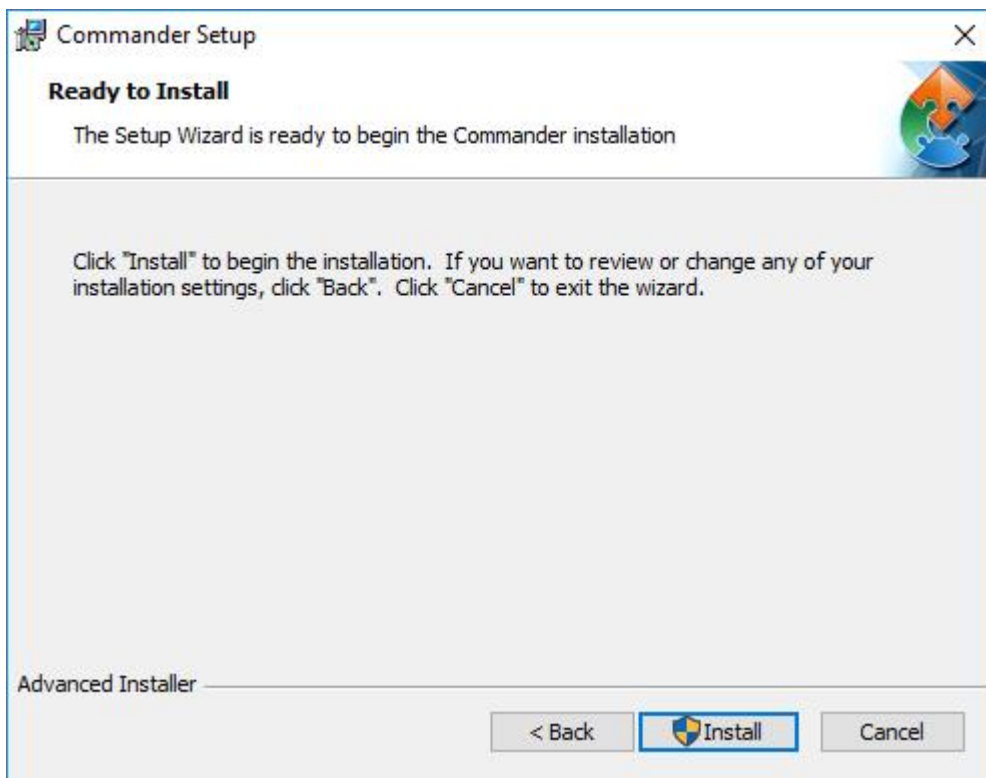

9. Click **Finish** to complete the installation.

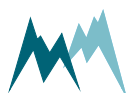

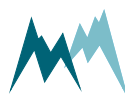
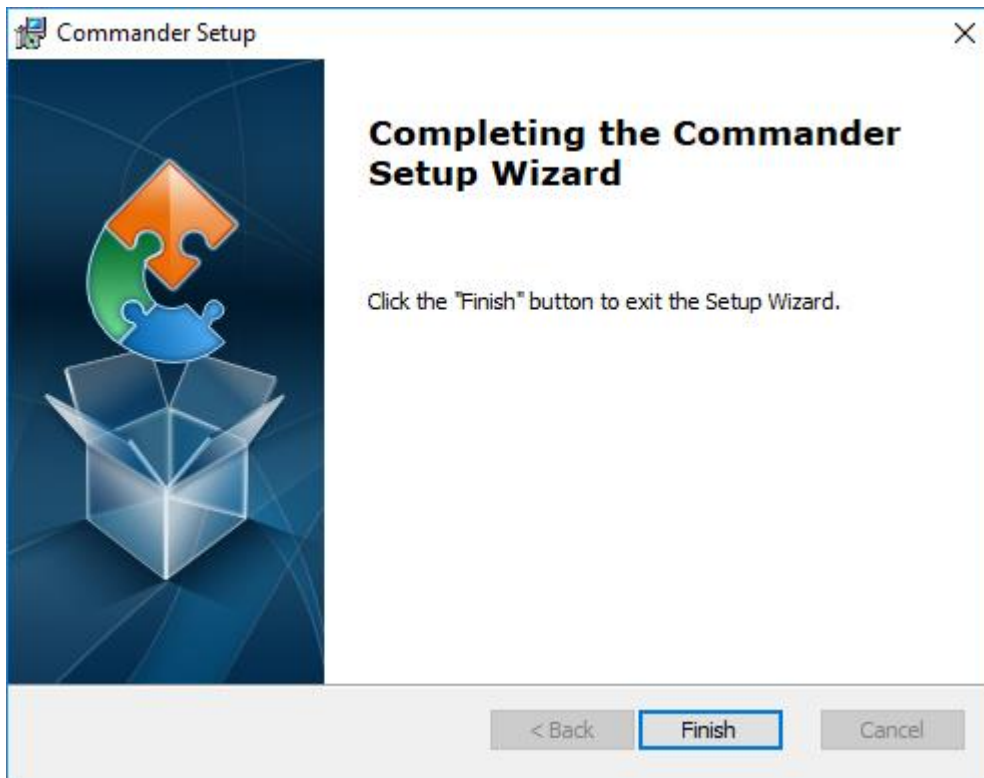

10 Configuration

The IDS-20d can be configured with one of the following tools:

- Configuration with Commander support software
- Configuration with a terminal program

10.1 Configuration with Commander support software

Follow the steps below to modify the configuration parameters of the IDS-20d:

1. Establish a connection between your PC and the IDS-20d as described in [Connect the IDS-20d to a PC](#).
2. Select the tab **Parameters (F2)** and click **Download parameters from device**. The complete parameter list is transferred from the sensor to your PC and displayed in the Parameter window.

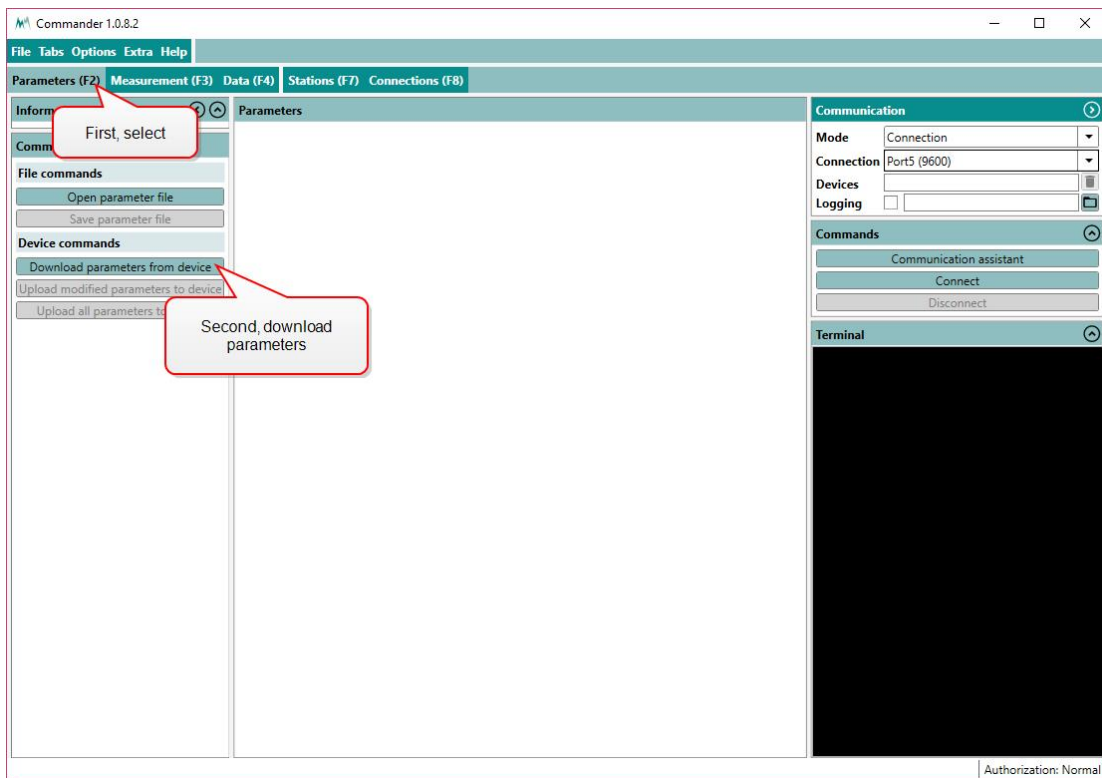

NOTE The first download of the parameter list may take a few minutes. After that the device is known to the PC and consecutive downloads are much faster.



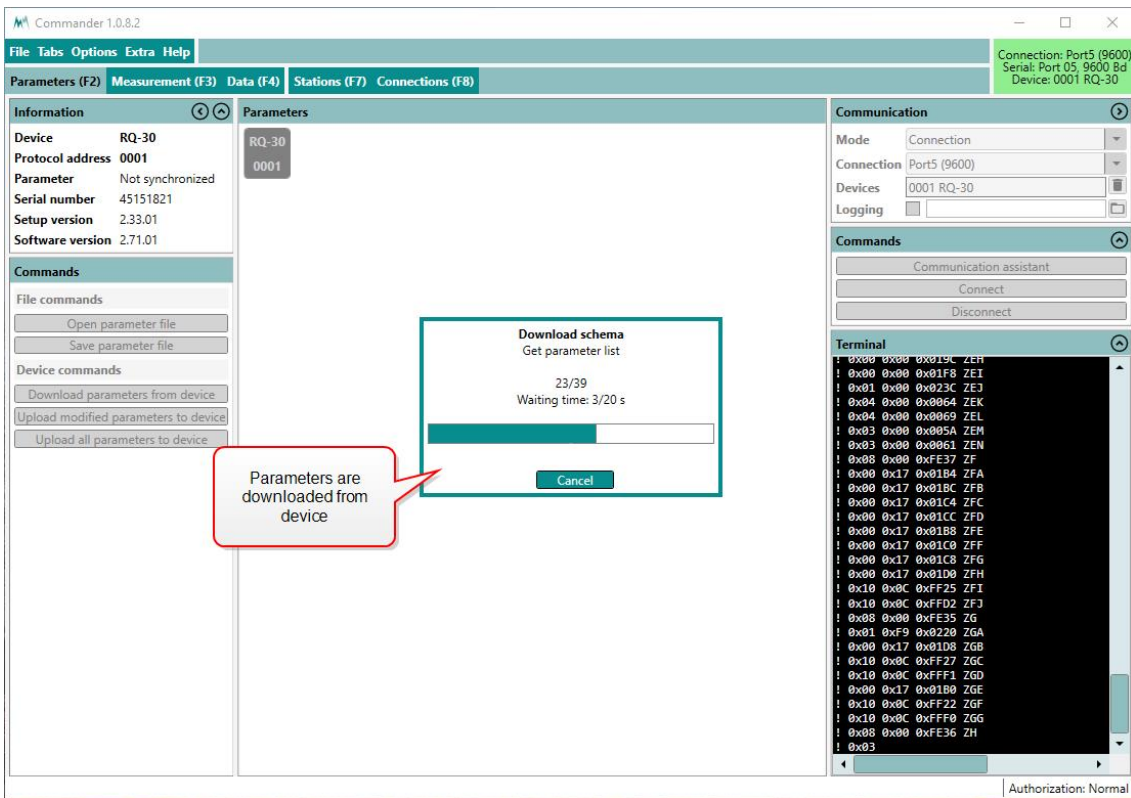

3. Save the parameter file to your PC by clicking **Save parameter file**. This step is recommended to track any configuration changes.

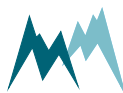
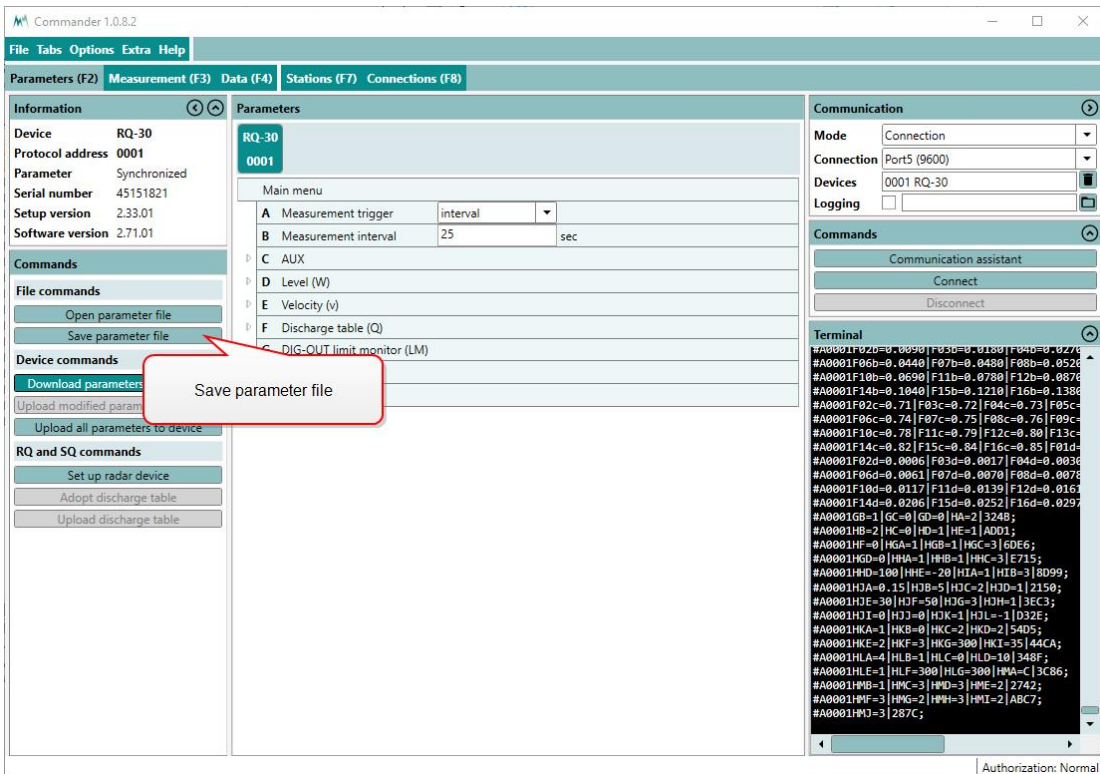

- Adapt the parameters required for your application. Changed values are displayed with a pink background.

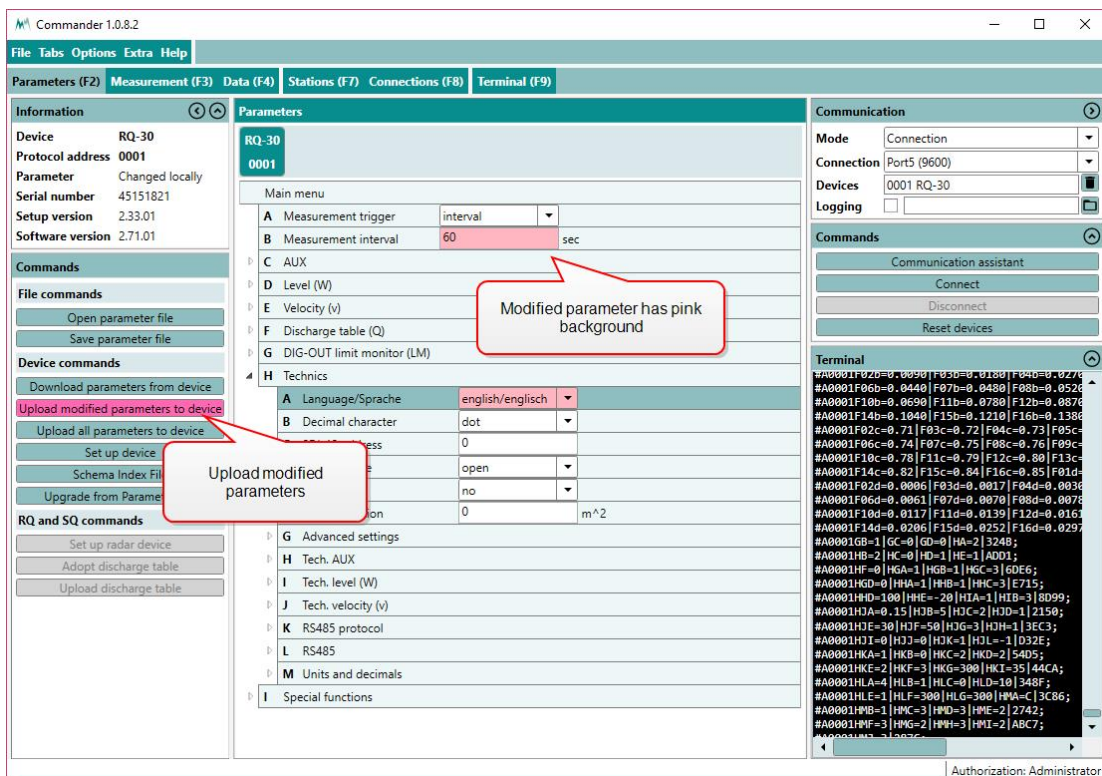

- Send the modifications to the IDS-20d by clicking **Upload modified parameters to device**. Upon successful upload the pink backgrounds disappear again.

10.2 Configuration with a terminal program

The Commander software ships with an integrated terminal program. However, communication with the IDS-20d can be performed with any terminal program.

Follow the steps below to modify the configuration parameters of the IDS-20d:

- Establish a connection between your PC and the IDS-20d.
- In the terminal window enter three question marks (???) in quick succession. The main parameter menu is displayed in response.

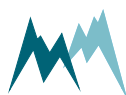

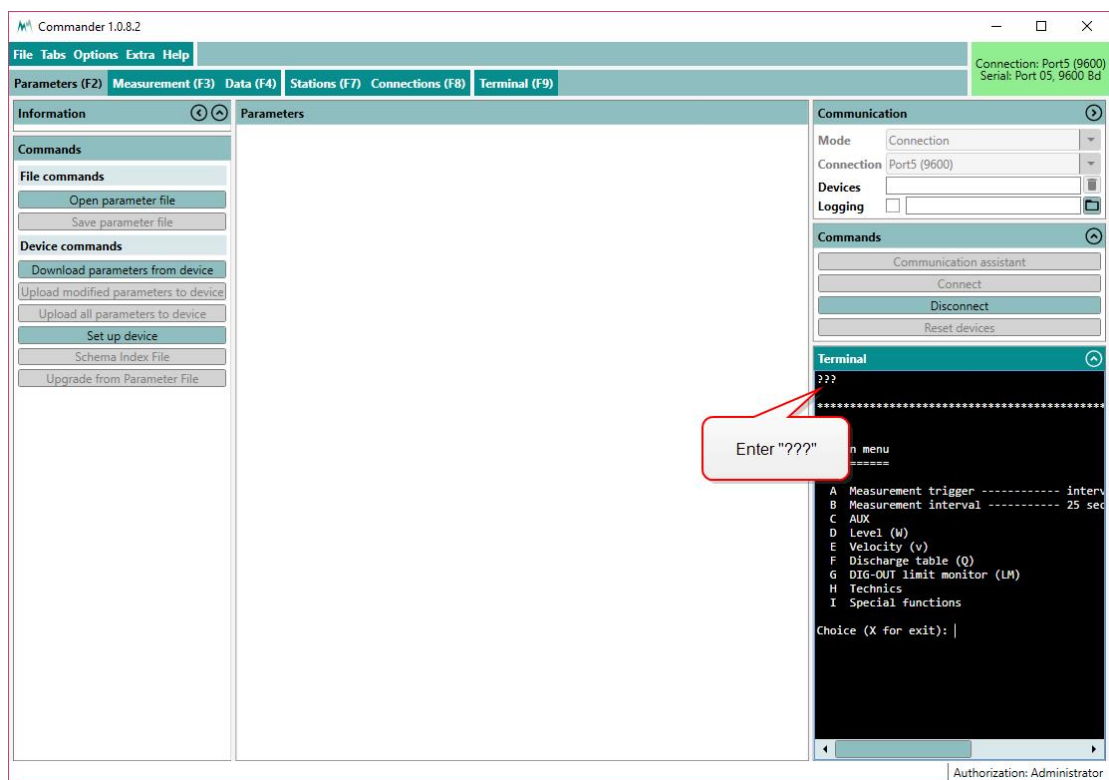

NOTE As an unwanted switching into the menu mode has to be avoided the timing of the three question marks ??? is very restrictive and must never be finished with Return/Enter. This is especially important for command line tools, which may automatically send a closing "Carriage return".

3. Read or modify the required parameters: The menu items can be selected by entering the letter assigned to each item. Upon selection a submenu is opened or the selected parameter is displayed with its unit. Changes to values are confirmed with **Return/Enter** or discarded with **Esc**. Menus are closed with **X**. After closing the main menu with **X** the sensor performs an initialization.

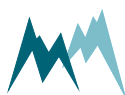

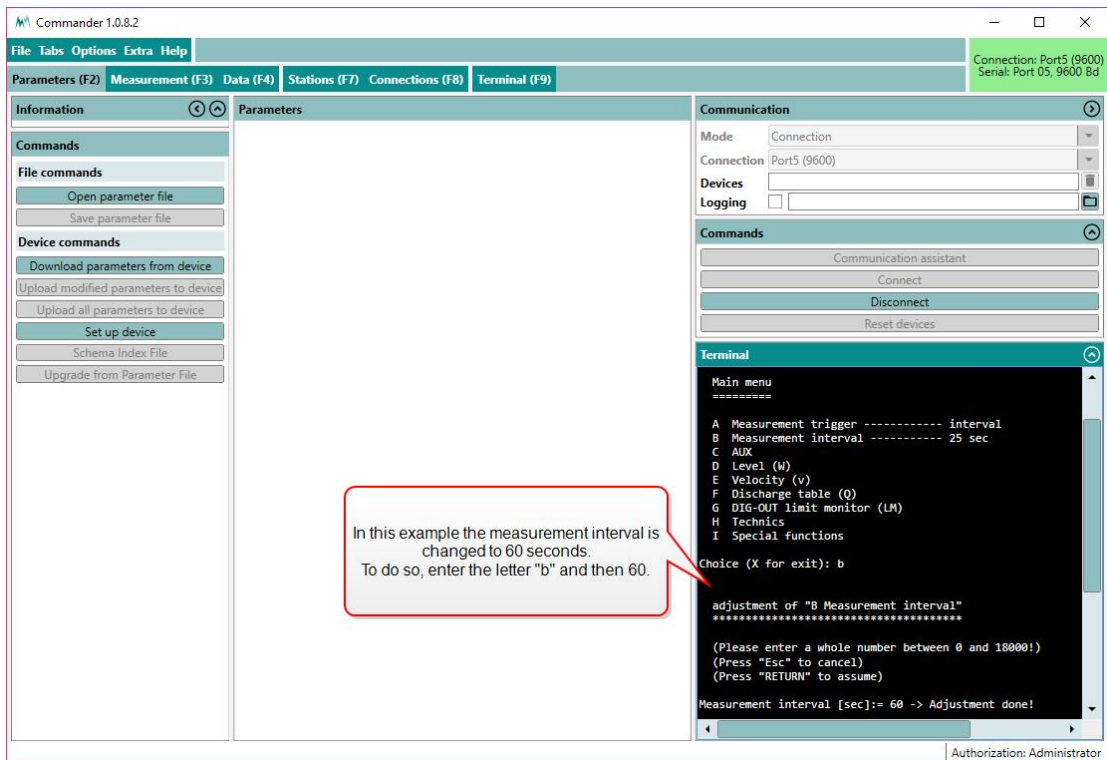

10.3 What do I need to configure?

When first setting-up a IDS-20d at a measurement site, the parameters described below may need to be adapted.

10.3.1 General settings

Language/Sprache

The menu language.

Decimal character

The character used as decimal separator in the values of the settings and in serial data strings.

Units and decimals

The units and number of decimal digits. These have to be set prior to all other settings as all values are saved internally in this format.

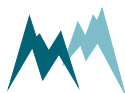



ATTENTION If units or decimals are changed, related parameters may need to be adjusted.

Measurement Interval

The interval at which continuous measurements are performed; default is 60 seconds.



ATTENTION The default measurement interval of 60 seconds should not be changed, as the heating configuration is optimized for this interval.

Output protocol (OP)

The type of the serial output protocol. The following options are available:

Option	Description
Sommer (default)	Sommer protocol; data values are returned with an index starting at 1
Standard	Standard protocol; data values are returned without an index
MODBUS	Modbus protocol

OP, information

The main measurement values are always included in the data output string. Additionally, special and analysis values can be included. See [Which data do I get?](#) for details.

10.3.2 Sensor setup

Sensor type

The type of sensor used. One of Cube 1, Cub 5, Rod T 80 or Custom.

Sensor S1, orientation and Sensor S2, orientation

The orientation of the sensor relative to geographic north. Use the black mark on the cube sensor for northing.

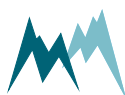

Sensor S1, zero adjust and Sensor S2, zero adjust

After connection of the sensors to the IDS-20d controller it needs to be verified that the sensor cables do not introduce any interfering capacities. This can be tested with the functions [Sensor S1, test](#) and [Sensor S2, test](#), which read the currently measured capacities of all sensor plates. Use the zero adjust functions to compensate for any capacities introduced by the sensor cables.



ATTENTION The zero adjust functions should only be applied during installation with dry sensor surfaces. Do not use this function during continuous operation as this may introduce a shift of icing measurements!

10.3.3 Heater configuration

Ice, maximum

The maximum ice accumulation before the sensor starts heating.

Ice, minimum

Thickness of the accumulated ice layer at which heating stops. This limit is only active in combination with the [Water, minimum](#) setting.

Water, maximum

The maximum water accumulation before the sensor starts heating.

Water, minimum

Thickness of the accumulated water layer at which heating stops. This limit is only active in combination with the [Ice, minimum](#) setting.

Maximum heating time

The maximum heating duration for one heating cycle. It prevents excess heating and damage of an ice-sensor. Generally, an ice-sensor is defrosted and dried in less than the default 600 sec. Except for extremely harsh environments it is recommended to use the default value.

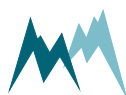

Cool down duration

The time required to cool down the ice-sensor to ambient conditions.

Meas. duration icing rate

It is recommended to determine the icing-rate over a longer period than a single measurement interval. This period can be specified with the icing-rate measurement duration.

10.3.4 Icing verification

With the IDS-20d icing of a connected sensor is verified by the following variables. All three conditions must be satisfied for ice to accrete on a sensor.

Maximum temperature

The temperature below which icing may occur. This depends on the meteorological conditions at the measurement site, e.g. wind speed, humidity or precipitation and may reach a few degrees Celsius plus.

Minimum humidity

The relative humidity above which icing may occur. This value may be as low as 80%.

Maximum water

The thickness of the water layer on the sensor below which icing may occur.

The result of the icing verification is also returned with the analysis values (indices 26 and 40). See [Measurement phases](#) for details.

10.3.5 Relay switching

The IDS-20d provides two relay outputs which can be configured to switch according to different limit values of the connected sensors. The wiring of the relay outputs is illustrated in [Figure 11](#).

Output value

The variable which controls relay A and/or B; either ice, water or ice and water. Different variables of the same sensor or the same variable of both sensors can be selected.

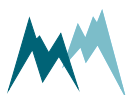

Sensor choice

One of the sensors for which the limit value is monitored.

Ice limit

The amount of ice accreted before the relay is switched.

Water limit

The amount of accumulated water before the relay is switched.

Ice rate limit

The rate at which ice accumulates before the relay is switched.

Functional switch at "OFF"

The IDS-20d contains an additional relay that responds to high ambient temperatures and the state of the device. To reduce power consumption icing measurements can be switched off if ambient temperatures are too high.

Generally, if an instrument failure occurs the relay opens. The relay can also be configured to open if the ambient temperature exceeds a certain limit.

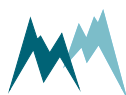

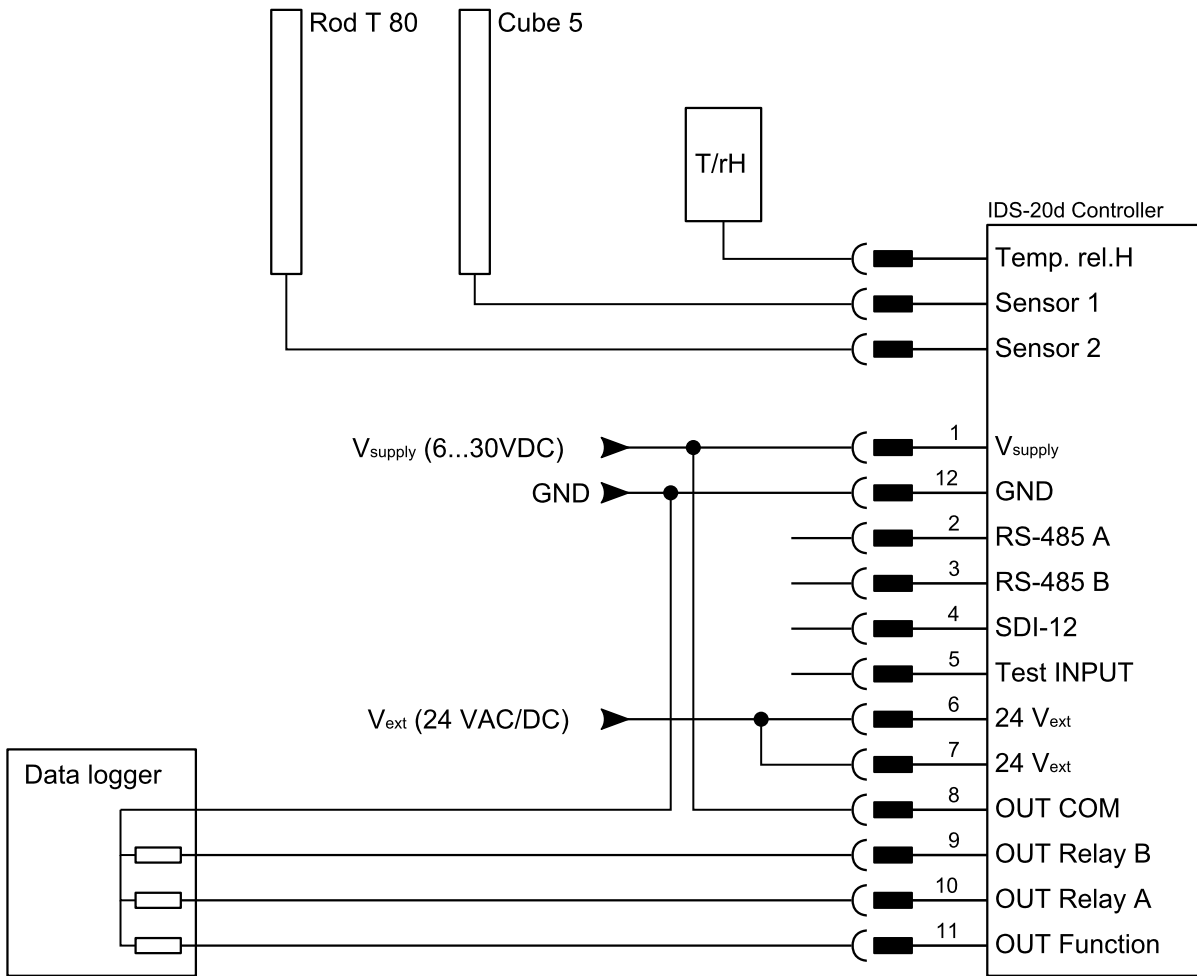
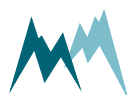

Figure 11 Wiring of relay outputs to a data logger



11 Serial communication

11.1 What are the options?

Serial data communication with the IDS-20d can be performed by

- RS-485
- Modbus
- SDI-12

11.2 Which data do I get?

The measurement values returned by the IDS-20d are arranged in a fixed sequence and identified by an index. They are divided into three groups and can be selected in [OP, information](#).

11.2.1 Main values

Index	Value	Unit	Description
01	Temperature	°C / F	Air temperature
02	Humidity	%	Humidity
03	Dew point	°C / F	Dew point
04	Relay A	0 / 1	State of relay A
05	Relay B	0 / 1	State of relay B
06	Relay function	0 / 1	State of measurement device
07	Sensor 1, Ice	mm	Current ice layer thickness on sensor 1
08	Sensor 1, Water	mm	Current water layer thickness on sensor 1
09	Sensor 1, Ice rate	mm/h	Current icing rate on sensor 1
10	Sensor 1, Temperature	°C / F	Surface temperature of sensor 1
11	Sensor 1, Direction	°	Icing direction of sensor 1



Index	Value	Unit	Description
12	Sensor 1, Direction value		Directional distinction of ice accretion; the higher the value the more pronounced icing is in a certain direction.
13	Sensor 2, Ice	mm	Current ice layer thickness on sensor 2
14	Sensor 2, Water	mm	Current water layer thickness on sensor 2
15	Sensor 2, Ice rate	mm/h	Current icing rate on sensor 2
16	Sensor 2, Temperature	°C / F	Surface temperature of sensor 2
17	Sensor 2, Direction	°	Icing direction of sensor 2
18	Sensor 2, Direction value		Directional distinction of ice accretion; the higher the value the more pronounced icing is in a certain direction.

11.2.2 Special values

Index	Value	Unit	Description
19	Relay A, counter		Sum of trigger events of relay A
20	Relay A, time	h	Total time relay A is on
21	Relay B, counter		Sum of trigger events of relay B
22	Relay B, time	h	Total time relay B is on
23	Heating current	A	Heating current
24	Supply Voltage	V	Supply voltage
25	Exception code		for diagnostic use of Sommer Messtechnik only

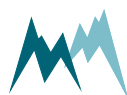

11.2.3 Analysis values

Index	Value	Unit	Description
26	Sensor 1, Measurement phase		Measurement phase of the sensor, see Measurement phases
27	Sensor 1, Ice raw	mm	Current ice layer thickness, not verified
28	Sensor 1, C P1 LF	pF	Capacity
29	Sensor 1, C P1 HF	pF	Capacity
30	Sensor 1, C P2 LF	pF	Capacity
31	Sensor 1, C P2 HF	pF	Capacity
32	Sensor 1, C P3 LF	pF	Capacity
33	Sensor 1, C P3 HF	pF	Capacity
34	Sensor 1, P P1 LF	°	Phase of the capacity measurement
35	Sensor 1, P P1 HF	°	Phase of the capacity measurement
36	Sensor 1, P P2 LF	°	Phase of the capacity measurement
37	Sensor 1, P P2 HF	°	Phase of the capacity measurement
38	Sensor 1, P P3 LF	°	Phase of the capacity measurement
39	Sensor 1, P P3 HF	°	Phase of the capacity measurement
40	Sensor 2, Measurement phase		Measurement phase of the sensor, see Measurement phases

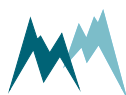

Index	Value	Unit	Description
41	Sensor 2, Ice raw	mm	Current ice layer thickness, not verified
42	Sensor 2, C P1 LF	pF	Capacity
43	Sensor 2, C P1 HF	pF	Capacity
44	Sensor 2, C P2 LF	pF	Capacity
45	Sensor 2, C P2 HF	pF	Capacity
46	Sensor 2, C P3 LF	pF	Capacity
47	Sensor 2, C P3 HF	pF	Capacity
48	Sensor 2, P P1 LF	°	Phase of the capacity measurement
49	Sensor 2, P P1 HF	°	Phase of the capacity measurement
50	Sensor 2, P P2 LF	°	Phase of the capacity measurement
51	Sensor 2, P P2 HF	°	Phase of the capacity measurement
52	Sensor 2, P P3 LF	°	Phase of the capacity measurement
53	Sensor 2, P P3 HF	°	Phase of the capacity measurement

11.2.4 Exception values

Measurement data may be returned with the following exception values:

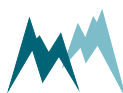

Value	Description
9999.998	Initial value: No measurement has been performed yet (position of decimal character is irrelevant).
9999.997	Conversion error: Caused by a technical problem (position of decimal character is irrelevant)
9999999	Positive overflow
-9999999	Negative overflow

Table 2: Exception values

11.3 RS-485

11.3.1 What is it?

RS-485 is a serial communication method for computers and devices. It is currently a widely used communication interface in data acquisition and control applications where multiple nodes communicate with each other.¹

11.3.2 What can I do with it?

RS-485 communication is primarily used to trigger measurements and read their results. It also permits to change parameters of the IDS-20d.

11.3.3 How do I wire it?

The IDS-20d can be connected to a data logger or a RS-485 network according to the figure below.

¹<https://www.lammertbies.nl/comm/info/RS-485.html>

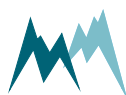

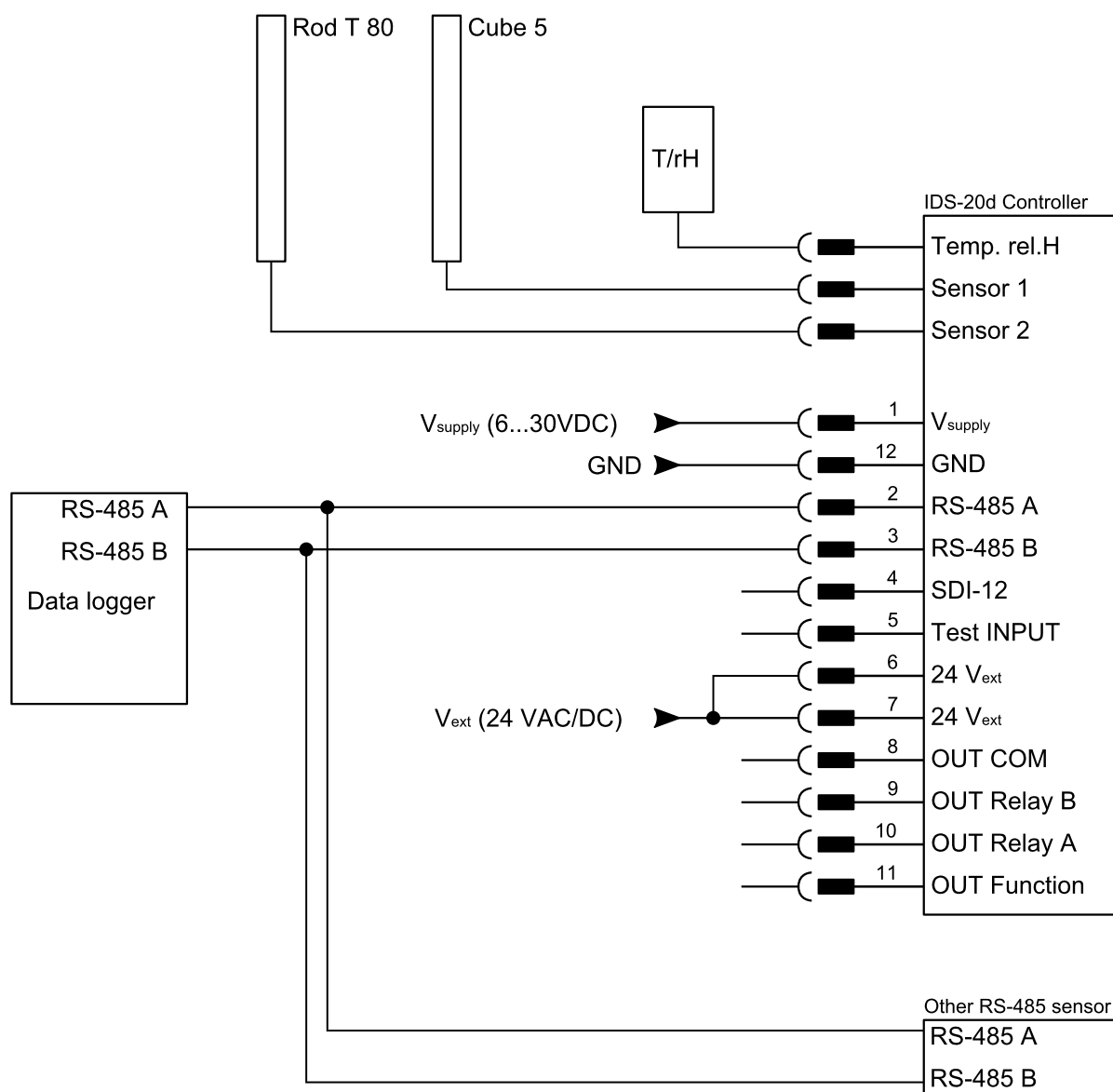

Figure 12 Wiring of the IDS-20d with a data logger via RS-485

11.3.4 How do I configure it?

The IDS-20d has serial RS-485 communication enabled by default. If the device is integrated into a RS-485 network or connected to a stand-alone data acquisition system, e.g. a data logger, the parameters listed in [RS-485 Protocol](#) may need to be adapted:

RS-485 Port

By default the serial port of the IDS-20d is configured as follows:

Baud rate	9600
Data bits	8
Parity	none
Stop bits	1
Flow control	none

System key and device number

The system key and device number are used to identify a IDS-20d in a bus system. This is essential if multiple devices (IDS-20d and data loggers) are operated within the same system.

System key

The system key separates different conceptual bus systems. This may be necessary if the remote radio coverage of two measurement systems overlap. In general, the system key should be set to *00*.

Device number

The device number is a unique number that identifies a device in a bus system.

OP, measurement output

The serial data output can be triggered in the following ways:

Option	Description
just per command	The output is only requested by commands via the RS-485 or SDI-12 interface.
after measurement (default)	The serial data output is performed automatically right after each measurement.
pos. TRIG slope	The output is triggered by a positive edge of a control signal applied to the trigger input.



NOTE If *OP, measurement output* is set to *pos. TRIG slope*, the data are returned with a delay of 200 ms after the trigger has been set. Make sure that your data acquisition system takes account of this lag to ensure that it receives the most recent data.

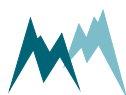

Waking-up a connected data logger

The IDS-20d supports wake-up of a connected data logger that is in standby mode. Generally, this feature is only used in pushing mode and can be set under [OP, wake-up sequence](#).

Sync sequence

The sync sequence is the string `UU~???` and is sent directly before a command. It is used to synchronize the receiving UART.

Prefix

The prefix is an arbitrary character; the IDS-20d uses a blank. This character is sent prior to any communication. Then the time of the [OP, prefix holdback](#) is waited and the command is sent afterwards. With this procedure the receiving device has time to wake-up.

Output protocols

For data output via RS-485 different protocols are available, which can be selected under [Output protocol \(OP\)](#).

11.3.5 How is the output structured?

Data are returned in two different formats, selectable in [Output protocol \(OP\)](#):

- [Sommer protocol](#)
- [Standard protocol](#)

11.3.6 Sommer protocol

The data string of the Sommer protocol has the following format:

 **EXAMPLE** #M0001G01se01 1461|02 1539|03
25.25|04 0|3883;

Header

The header (`#M0001G00se`) identifies the data by system key, device number and string number.

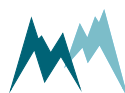

Parameter	Format	Description
Start character	#	
Identifier	M	M identifies an output string
System key	dd	
Device number	dd	
Command ID	G	G defines an output string with string number
String number	dd	01 Main values 03 Special values 05 Analysis values 06 Analysis values
Command	se	se identifies automatically sent values

Table 3: Header of the Sommer protocol

Measurement value

A measurement value (02 1539 |) has a length of 8 digits and is returned together with its index. If the measurement value is a decimal number, one digit is reserved for the decimal character. Values are returned right-aligned, so blanks may occur between index and value.

Parameter	Format	Description
Index	dd	2 numbers
Value	xxxxxxxx	8 character right-aligned
Separator		

Table 4: Values in Sommer protocol

End sequence

The data string is terminated with a CRC-16 in hex format (3883) followed by an end character and <CR><LF>. The CRC-16 is described in [Sommer CRC-16](#).

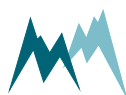

Parameter	Format	Description
CRC-16	Hhhh	4-digit hex number
End character	;	
Control characters	<CR><LF>	Carriage return and Line feed

Table 5: End sequence of the Sommer protocol

Example Sommer protocol

Main values

Main values are returned as in the following example:

EXAMPLE				
#M0001G01se01	27.8 02	35.8 03	11.2 04	
0 05	0 06	1 9440;		
#M0001G02se07	0.00 08	0.04 09	0.00 10	
27.4 11	12	CA86;		
#M0001G03se13	0.00 14	31.50 15	0.00 16	
28.1 17	18	F592;		

#M0001G01se	Header with system key 00, device number 01 and string number 01
01 27.8	Temperature
02 35.8	Humidity
03 11.2	Dew point
04 0	Relay A
05 0	Relay B
06 1	Relay function
9440;	Closing sequence
#M0001G02se	Header with system key 00, device number 01 and string number 02

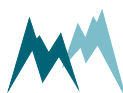

07	0.00	Sensor 1, Ice
08	0.04	Sensor 1, Water
09	0.00	Sensor 1, Ice rate
10	27.4	Sensor 1, Temperature
11		Sensor 1, Direction
12		Sensor 1, Direction value
CA86;		Closing sequence
#M0001G03se		Header with system key 00, device number 01 and string number 03
13	0.00	Sensor 2, Ice
14	31.50	Sensor 2, Water
15	0.00	Sensor 2, Ice rate
16	28.1	Sensor 2, Temperature
17		Sensor 2, Direction
18		Sensor 2, Direction value
F592;		Closing sequence

Table 6: Main values in Sommer new protocol

Special values

Special values are returned as in the following example:

 **EXAMPLE** #M0001G10se19 125|20 70.0|21
 112|22 61.6|23 0.00|24 10.64|25
 0.00|EA03;

#M0001G10se		Header with system key 00, device number 01 and string number 10
19	125	Relay A, counter

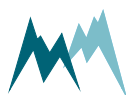

20	70.0	Relay A, time
21	112	Relay B, counter
22	61.6	Relay B, time
23	0.00	Heating current
24	10.64	Supply Voltage
25	0.00	Exception code
EA03;		Closing sequence

Table 7: Special values in Sommer new protocol

Analysis values

Analysis values are returned as in the following example:

✓	EXAMPLE				
	#M0001G20se26	1.06 27	0.00 28	29.94 29	
	30.05 30	30.03 31	30.15 32	30.24 828D;	
	#M0001G21se33	30.34 34	-89.93 35	-88.48 36	-
	89.93 37	-88.43 38	-89.97 39	-88.65 D629;	
	#M0001G22se40	1.04 41	0.00 42	89.34 43	
	89.56 44	89.15 45	89.31 46	89.71 138B;	
	#M0001G23se47	89.94 48	-89.93 49	-89.66 50	-
	89.91 51	-89.58 52	-89.92 53	-89.66 B46F;	

#M0001G20se		Header with system key 00, device number 01 and string number 20
26	1.06	Sensor 1, Measurement phase
27	0.00	Sensor 1, Ice raw
28	29.94	Sensor 1, C P1 LF
29	30.05	Sensor 1, C P1 HF



30	30.03	Sensor 1, C P2 LF
31	30.15	Sensor 1, C P2 HF
32	30.24	Sensor 1, C P3 LF
828D;		Closing sequence
#M0001G21se		Header with system key 00, device number 01 and string number 21
33	30.34	Sensor 1, C P3 HF
34	-89.93	Sensor 1, P P1 LF
35	-88.48	Sensor 1, P P1 HF
36	-89.93	Sensor 1, P P2 LF
37	-88.43	Sensor 1, P P2 HF
38	-89.97	Sensor 1, P P3 LF
39	-88.65	Sensor 1, P P3 HF
D629;		Closing sequence
#M0001G22se		Header with system key 00, device number 01 and string number 22
40	1.04	Sensor 2, Measurement phase
41	0.00	Sensor 2, Ice raw
42	89.34	Sensor 2, C P1 LF
43	89.56	Sensor 2, C P1 HF
44	89.15	Sensor 2, C P2 LF
45	89.31	Sensor 2, C P2 HF
46	89.71	Sensor 2, C P3 LF

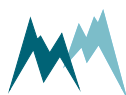

138B;	Closing sequence
#M0001G23se	Header with system key 00, device number 01 and string number 23
47 89.94	Sensor 2, C P3 HF
48 -89.93	Sensor 2, P P1 LF
49 -89.66	Sensor 2, P P1 HF
50 -89.91	Sensor 2, P P2 LF
51 -89.58	Sensor 2, P P2 HF
52 -89.92	Sensor 2, P P3 LF
53 -89.66	Sensor 2, P P3 HF
B46F;	Closing sequence

Table 8: Analysis values in Sommer new protocol

11.3.7 Standard protocol

The data string of the Standard protocol has the following format:

	EXAMPLE M_0001 1461 1359 25.38 0
---	---

Header

The header (M_0001) identifies the data by system key and device number.

Parameter	Format	Description
Identifier	X_	M_ Measurement values S_ Special values V_ Analysis values
System key	Dd	
Device number	Dd	

Table 9: Header of the Standard protocol

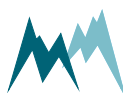

Measurement values

Measurement values are returned in sequence and are separated by a blank. A measurement value has a length of 8 digits. If the measurement value is a decimal number, one digit is reserved for the decimal character. Values are returned right-aligned, so additional blanks may be returned between values.

Parameter	Format	Description
Separator	[blank]	blank
Value	xxxxxxxx	8 character right-aligned

Table 10: Values in Standard protocol

End sequence

The data string is terminated with <CR><LF>.

Example Standard protocol

Main values

Main values are returned as in the following example:

✓	EXAMPLE M_0001	28.1	34.9	11.2	0	
	0	1	0.00	0.03	0.00	27.9
	0.00	31.50	0.00	28.4		

M_0001	Header with identifier for measurement values
28.1	Temperature
34.9	Humidity
11.2	Dew point
0	Relay A

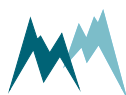

0	Relay B
1	Relay function
0.00	Sensor 1, Ice
0.03	Sensor 1, Water
0.00	Sensor 1, Ice rate
27.9	Sensor 1, Temperature
0.00	Sensor 1, Direction
31.5	Sensor 1, Direction value
0	Sensor 2, Ice
0.0	Sensor 2, Water
0	Sensor 2, Ice rate
28.4	Sensor 2, Temperature

Table 11: Main values in Standard protocol

Special values

Special values are returned as in the following example:

	EXAMPLE	S_0001	125	70.0	112	61.6
		-0.01	11.30	0.32		

S_0001	Header with identifier for measurement values
125	Relay A, counter
70.0	Relay A, time
112	Relay B, counter

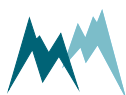

61.6	Relay B, time
-0.01	Heating current
11.30	Supply Voltage
0.32	Exception code

Table 12: Main values in Standard protocol

Analysis values

Analysis values are returned as in the following example:

✓	EXAMPLE V_0001	1.06	0.00	29.93	30.05	
	30.03	30.14	30.23	30.34	-89.93	-88.47
	-89.92	-88.43	-89.97	-88.65	1.04	
	0.00	89.32	89.55	89.14	89.32	89.71
	89.94	-89.93	-89.66	-89.91	-89.58	-89.92
	-89.65					

V_0001	Header with identifier for analysis values
1.06	Sensor 1, Measurement phase
0	Sensor 1, Ice raw
29.93	Sensor 1, C P1 LF
30.05	Sensor 1, C P1 HF
30.03	Sensor 1, C P2 LF
30.14	Sensor 1, C P2 HF
30.23	Sensor 1, C P3 LF
30.34	Sensor 1, C P3 HF
-89.93	Sensor 1, P P1 LF
-88.47	Sensor 1, P P1 HF

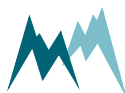

-89.92	Sensor 1, P P2 LF
-88.43	Sensor 1, P P2 HF
-89.97	Sensor 1, P P3 LF
-88.65	Sensor 1, P P3 HF
1.04	Sensor 2, Measurement phase
0	Sensor 2, Ice raw
89.32	Sensor 2, C P1 LF
89.55	Sensor 2, C P1 HF
89.14	Sensor 2, C P2 LF
89.32	Sensor 2, C P2 HF
89.71	Sensor 2, C P3 LF
89.94	Sensor 2, C P3 HF
-89.93	Sensor 2, P P1 LF
-89.66	Sensor 2, P P1 HF
-89.91	Sensor 2, P P2 LF
-89.58	Sensor 2, P P2 HF
-89.92	Sensor 2, P P3 LF
-89.65	Sensor 2, P P3 HF

Table 13: Analysis values in Standard protocol

11.3.8 Which commands are available?

Command structure

The structure of serial commands and answers (`#W0001$mt|BE85;`) is described in the following table:



Parameter	Format	Description
Start character	#	
Identifier	X	<p>W IDS-20d returns a confirmation on receipt. This command type demands a closing sequence with a valid CRC-16.</p> <p>S IDS-20d does not acknowledge the receipt of the command. This command type demands no closing sequence and therefore no CRC-16.</p> <p>R IDS-20d returns the requested measurement value or parameter. This command type demands a closing sequence with a valid CRC-16.</p> <p>T Write a volatile setting and receive a confirmation</p> <p>A Answer of device to read or write command</p>
System key	dd	
Device number	dd	
Command	xxx	See Commands
Separator		
CRC-16	hhhh	4-digit hex number
End character	;	

Table 14: Structure of RS-485 commands and answers

Commands

The following commands can be used with the IDS-20d:

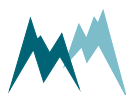

Command	Description
\$mt	Trigger a measurement
\$pt	Return measurement values
XX	Read a parameter with identifier XX
XX=xxxx	Write a parameter with identifier XX and the value xxx

Table 15: List of RS-485 commands

Trigger a measurement

The command \$mt triggers a complete measurement sequence as in the following example:

 **EXAMPLE** #W0001\$mt|BE85; Answer: #A0001ok\$mt|4FA9;

Read a parameter value

Read measurement interval (in the example below the menu item B):

 **EXAMPLE** #R0001B|228E; Answer: #A0001B=300|F8B3;

Request a complete data string

The command \$pt requests a data string as in the following example:

 **EXAMPLE** #S0001\$pt| Answer: none

The data string is returned as soon as the IDS-20d has processed the command.

Request a single measurement value

The reading command R together with the index of the requested measurement returns a single measurement value. In the following example the measurement value with index 01 (in this example a water level) is requested:

 **EXAMPLE** #R0001_010cv|EA62;





Answer: #A0001ok_010cv1461 | 07EB;

11.3.9 Sommer CRC-16

The CRC-16 (cyclic redundancy check) used in data transmission of Sommer devices is based on the ZMODEM protocol. When data are exchanged between two devices the receiving device calculates the CRC-value. This value is compared to the CRC value sent by the other device to check if the data were transmitted correctly. Please refer to technical literature or contact Sommer for calculation of CRC-16 values.

11.4 SDI-12

11.4.1 What is it?

SDI-12 (Serial Data Interface at 1200 Baud) is a serial data communication standard for interfacing multiple sensors with a single data recorder. For a detailed description on SDI-12 communication please refer to www.sdi-12.org.

11.4.2 What can I do with it?

The IDS-20d listens to standard SDI-12 commands as listed in the SDI-12 specifications of version 1.3, e.g., to trigger a measurement or retrieve measurement results. Additionally, a set of extended SDI-12 commands is implemented in all SOMMER sensors for instrument configuration.

11.4.3 How do I wire it?

The IDS-20d can be connected to a data logger via SDI-12 according to the figure below.

SDI-12 uses a shared bus with a ground wire, a data wire (indicated as SDI-12) and an optional +12 V wire.



NOTE The connection with the 12 V power supply is optional and depends on the connected SDI-12 master device (typically a data logger).

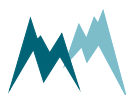

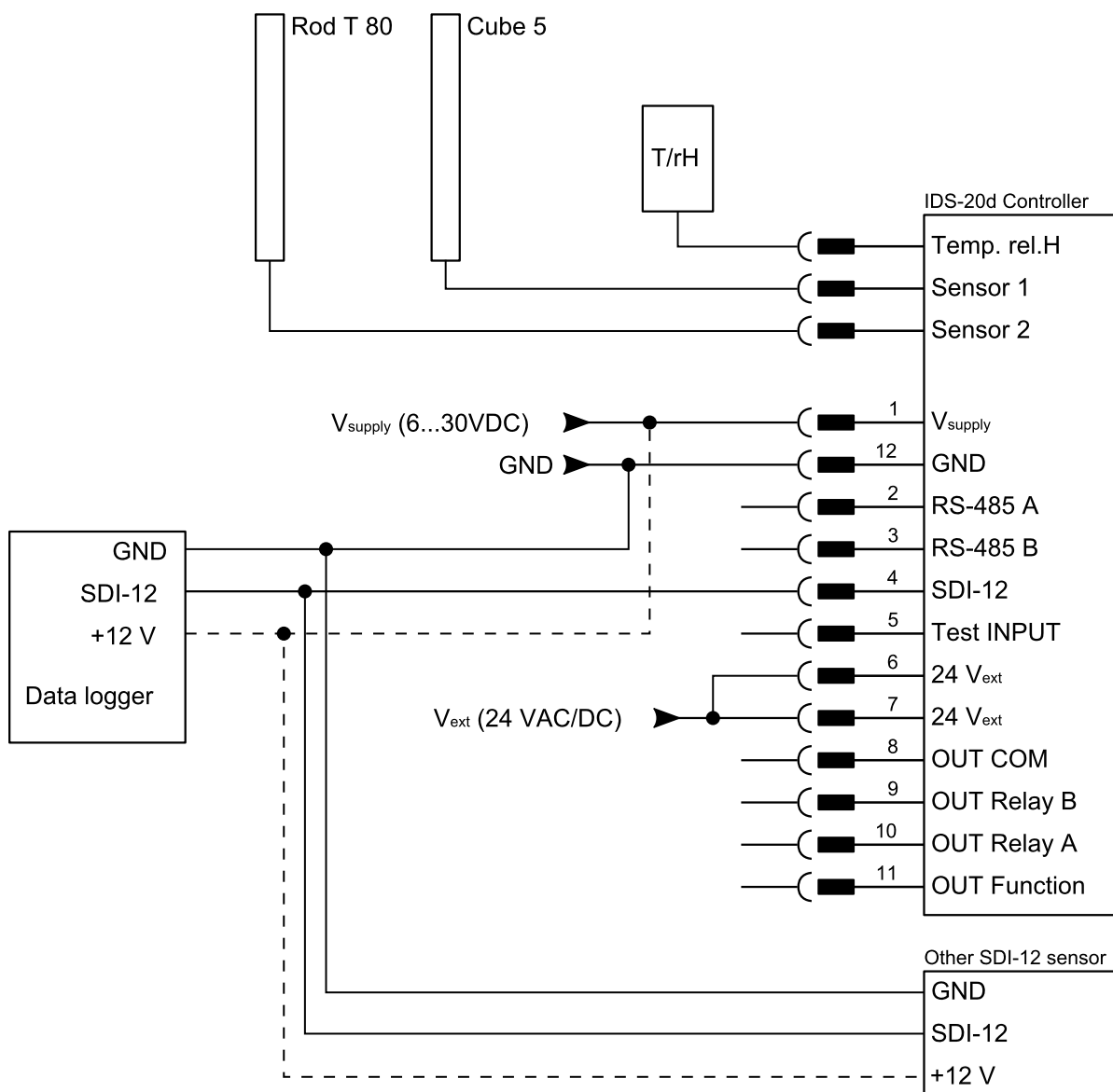

Figure 13 Wiring of the IDS-20d with a data logger via SDI-12

11.4.4 How do I configure it?

The IDS-20d has SDI-12 communication enabled by default. If the device is connected to a data acquisition system, e.g. data logger, and if multiple SDI-12 devices are connected to the same bus, the [SDI-12 address](#) may need to be adapted.

11.4.5 How are commands structured?

A standard SDI-12 command starts with the sensor address and ends with an exclamation mark, e.g., 0M!.

The answer from the SDI-12 device is a string containing the sensor address, the requested data and a terminating carriage return/line feed, e.g.,



EXAMPLE 0+2591+706+25.53+0<CR><LF>

11.4.6 Which commands are available?

The following tasks can be performed with standard and extended SDI-12 commands.

Extended SDI-12 commands are non-standard commands implemented by SOMMER to enable device configuration via SDI-12.



NOTE After any changes, the settings have to be adopted with the command `aXW_ts|!`, with `a` the sensor address.

Identify device

The identification of a SDI-12 device is requested with the command `aI!`, with `a` the sensor address.



EXAMPLE

0I! Answer 013Sommer USH 140r90 USH-9 <CR><LF>

The answer contains the following information:

0	SDI-12 address
1	SDI-12 version prior to the point
3	SDI-12 version after the point
Sommer	Description of the company (6 characters and 2 blanks)
USH	Description of the firmware (5 characters and 2 blanks)
140r90	Firmware version (6 characters and 2 blanks)
IDS-20d	Device designation (max. 13 characters)

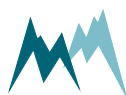

Acquire measurements

To acquire a measurement from a sensor, two individual SDI-12 commands – trigger a measurement and request measurement values – need to be sent.



EXAMPLE

0M! Answer: 00084<CR><LF> and 0<CR><LF> after 8 seconds

0D0! Answer: 0+2591+706+25.53+0<CR><LF>

The first values in the response to the aDn! command is the sensor address.

Trigger measurement

The command aM! with sensor address a triggers a measurement as in the example below.

The response states the measurement duration and the number of measurement values (see example below). After completion of the measurement, the device will return an additional a<CR><LF>, with a the sensor address.



EXAMPLE

0M! Answer: 00084<CR><LF> and 0<CR><LF> after 8 seconds

The answer contains the following information:

0 SDI-12 address

008 Duration of the measurement in seconds

4 Number of measurement values

Request results

After each measurement, results are requested with the command aDn!, with a the sensor address and n the index of the returned data string.



EXAMPLE 0D0! Answer: 0+2591+706+25.53+0<CR><LF>

The leading 0 of the response is the sensor address.

Generally, the command aD0! is sufficient to request up to 9 measurement values. If more than 9 values need to be read, or if the values are returned in groups, the commands aD1!, aD2!,... may need to be issued after aD0!. For example, if a measurement returns 8 values in two groups of 4, the commands aD0! and aD1! need to be issued to receive all values.

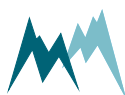

Acquire continuous measurements

If the SDI-12 device is operating in continuous measurement mode (not polled by SDI-12), the command `aR0!` will request and return the current reading of the sensor. The values within the data string follow the order listed in the measurement table. The first values in the response to the `aRn!` command is the sensor address.



EXAMPLE

`0R0!` Answer: `0+2591+706+25.53+0<CR><LF>`

If more than 9 values need to be read, or if the values are returned in groups, the commands `aR1!`, `aR2!`,... may need to be issued after `aR0!`. For example, if a measurement returns 8 values in two groups of 4, the commands `aR0!` and `aR1!` need to be issued to receive all values.

Configure device

The configuration parameters of a SOMMER sensor are read with the command `aXRpp!` and written with the command `aXWpp=vvv!`, with `a` the sensor address, `pp` the parameter identifier and `vvv` the value of the parameter.

Read and write a parameter



EXAMPLE

Reading of measurement interval (in this example menu item B)

`0XRB|!` Answer: `0B=300|<CR><LF>`

Setting of measurement interval to 60 s (in this example menu item B)

`0XWB=60|!` Answer: `0B=60|<CR><LF>`

Read and write a parameter with options

Changing the measurement trigger (in the following example menu item A) from *interval* to *SDI-12/RS485*:



EXAMPLE

`0XRA|!` Answer: `0A=1|<CR><LF>`

`0XWA=3|!` Answer: `0A=3|<CR><LF>`

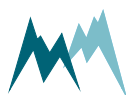

Read and write a parameters of a table

Some SOMMER sensors are equipped with multiple transducers and their settings are listed in a table (see example below). A value within such a table is addressed by its row-index (01, 02 ...) and column-index (A, B ...). A corresponding SDI-command has the following format:



EXAMPLE

In this example of a snow scale the value in row 01 and column B of the parameter D-D-E is changed to -1.4.

`0XWDDE01B=-1.4|!`

Answer: `0DDE01b=-1.4|<CR><LF>`

	Identifier	offset zero kg	gain	zero default kg	gain default
01	Load Cell 1	-1.4	0,997787	0,000	0,997787
02	Load Cell 2	0,000	0,997787	0,000	0,997787
03	Load Cell 3	0,000	0,997787	0,000	0,997787
04	Load Cell 4	0,000	0,997787	0,000	0,997787

Adopt settings

Some settings need to be adopted with the command `aXW_ts|!`, with `a` the sensor address. It is recommended to issue `aXW_ts|!` after each configuration change.

11.5 Modbus

11.5.1 What is it?

Modbus is a serial communication protocol used for transmitting information over serial lines between electronic devices. The device requesting the information is called the Modbus Master and the devices supplying information are Modbus Slaves. In a standard Modbus network, there is one Master and up to 247 Slaves, each with a unique Slave Address from 1 to 247. The Master can also write information to Slaves.

Modbus has become a standard communication protocol in industry, and is now the most commonly available means of connecting industrial electronic devices. It is often used to connect a supervisory computer with a remote terminal unit (RTU) in supervisory control and data acquisition (SCADA) systems. Versions of the Modbus protocol exist for serial lines (Modbus RTU and Modbus ASCII) and for Ethernet (Modbus TCP).¹

¹<http://www.simplymodbus.ca/FAQ.htm>

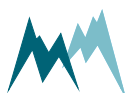

11.5.2 What can I do with it?

Modbus-communication with IDS-20d allows reading of measurement values and device information by a Modbus master. Additionally, the basic RS-485 port settings can be written to the IDS-20d.

11.5.3 How do I wire it?

For Modbus communication the IDS-20d is wired according to the table below.

Modbus	Connector MAIN	Connection wire	Description
Common	BUS-1 G	GND	Common
D1 - B/B	BUS-1 B	RS-485 A	D1 - B/B
D0 - A/A	BUS-1 A	RS-485 B	D0 - A/A

Table 16: Connection to a Modbus



NOTE If the IDS-20d is operated with multiple Modbus devices within the same network, termination resistors may be required. Please contact Sommer Messtechnik for details.

11.5.4 How do I configure it?

Follow the instructions below to change the communication of a Sommer-device (in this example a RG-30) to Modbus:

1. Connect the USB to RS-485 converter to the data cable of the Sommer-device and a USB port on your PC.
2. Connect the sensor to a power supply with the specified rating.
3. Start the Commander software on your PC.
4. Establish a connection to the Sommer-device.
5. Download the sensor's parameters in the [Parameters \(F2\)](#) tab and save the parameter list on your PC.

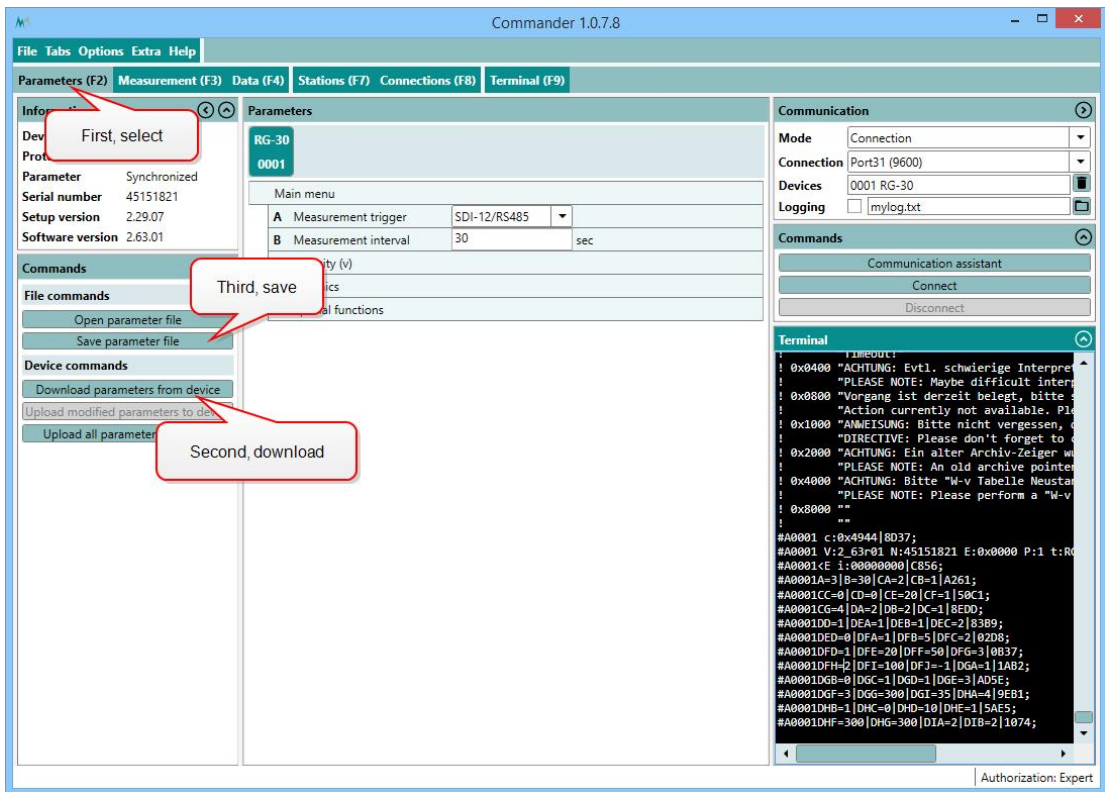

- In the parameter list navigate to Technics and open the menus [RS-485 protocol](#) and [RS485](#) and take a screenshot of the associated parameters. This and the previous step are helpful if you need to switch back to the standard communication mode at a later time.

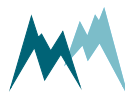

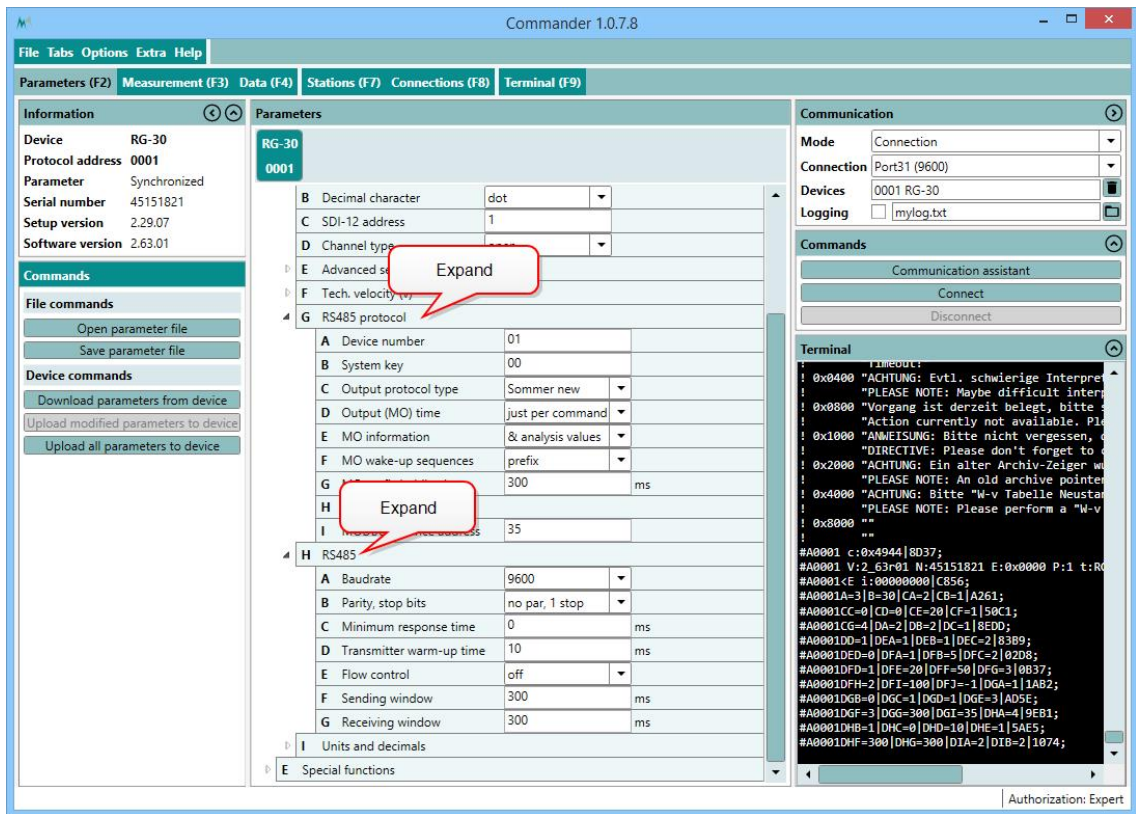

7. Set **Measurement trigger** to one of the following options:
 - A. *Interval*, if measurements are triggered internally by the device.
 - B. *SDI-12/RS-485*, if measurements are triggered by SDI-12.
 - C. *TRIG input*, if measurements are triggered by a trigger input.
 - D. *all allowed*, if measurements are triggered by one of the previous options.



NOTE Modbus cannot trigger measurements! Make sure to use the trigger option suitable for your application!

8. Verify that the connection to the Sommer-device is active and click into the Terminal window. Type `???` to enter the sensor-menu.

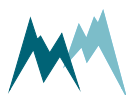

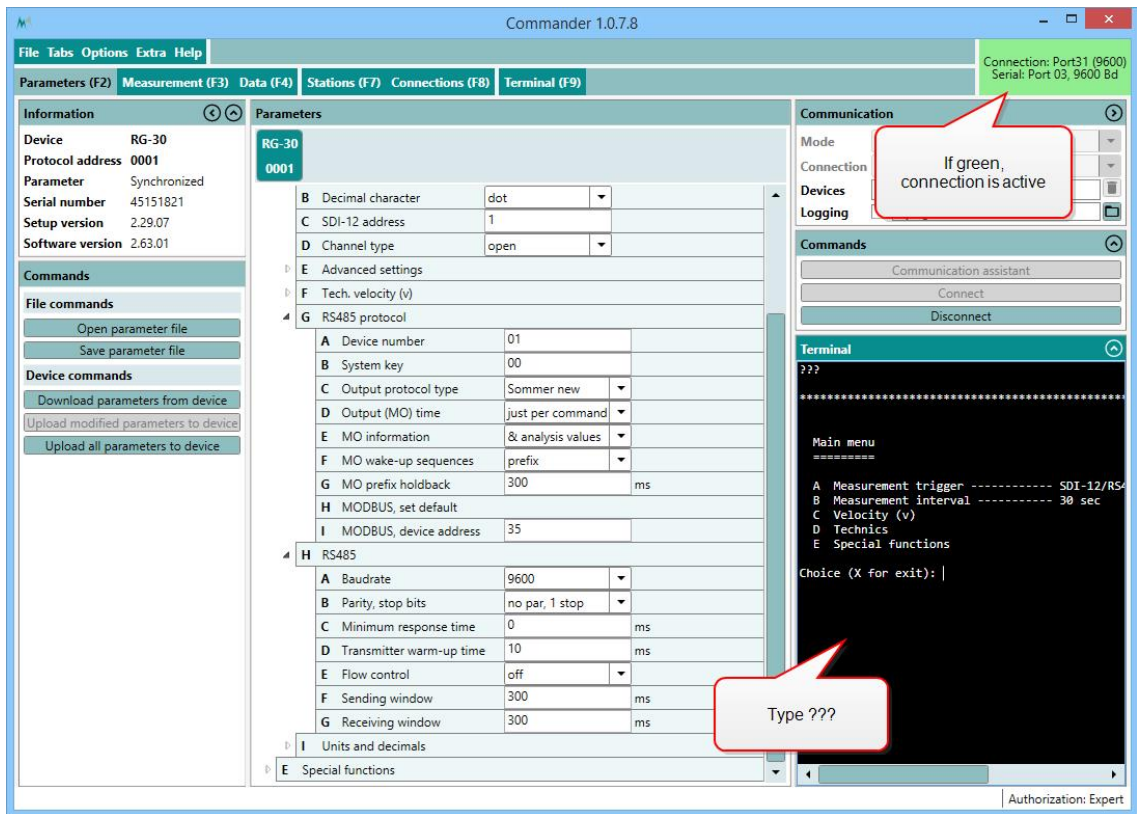

- Navigate to *RS485 protocol* and select *MODBUS, set default...* Please note, that the index-letters might be different for your Sommer-device!

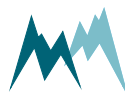

```

Terminal
Main menu
=====
A Measurement trigger ----- SDI-12/RS485
B Measurement interval ----- 30 sec
C Velocity (v)
D Technics
E Special functions

Choice (X for exit): d

Technics
=====
A Language/Sprache ----- english/englisch
B Decimal character ----- dot
C SDI-12 address ----- 1
D Channel type ----- open
E Advanced settings
F Tech. velocity (v)
G RS485 protocol
H RS485
I Units and decimals

Choice (X for exit): g

RS485 protocol
=====
A Device number
B System key --
C Output protoc
D Output (MO) t
E MO informatio
F MO wake-up se
G MO prefix holdback ----- 100 ms
H MODBUS, set default...
I MODBUS, device address ----- 35

Choice (X for exit): |
    
```

Enter the letter of 'MODBUS, set default ...'

10. Acknowledge the safety-note.

```

Start up testmode: 0x09

MODBUS, set default
AAAAAAAAAAAAAAAAAAAA

PLEASE NOTE: This process changes to 19200 baud, even parity, ...
DIRECTIVE: Please don't forget to change the serial counterpart too!

Are you sure?

(Press "RETURN" to assume)
(Press "Esc" to cancel)
    
```

Press Enter

11. After completion the following message will be displayed:

```

=> Testmode finished!

=> DIRECTIVE: Please don't forget to change the serial counterpart too!
    
```

12. Enter X until you get back to the main menu. The Sommer-device is now restarted and available for Modbus-communication. As the connection-parameters have been changed to Modbus, the connection to the sensor is lost. Press Disconnect for completion.

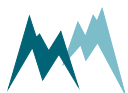

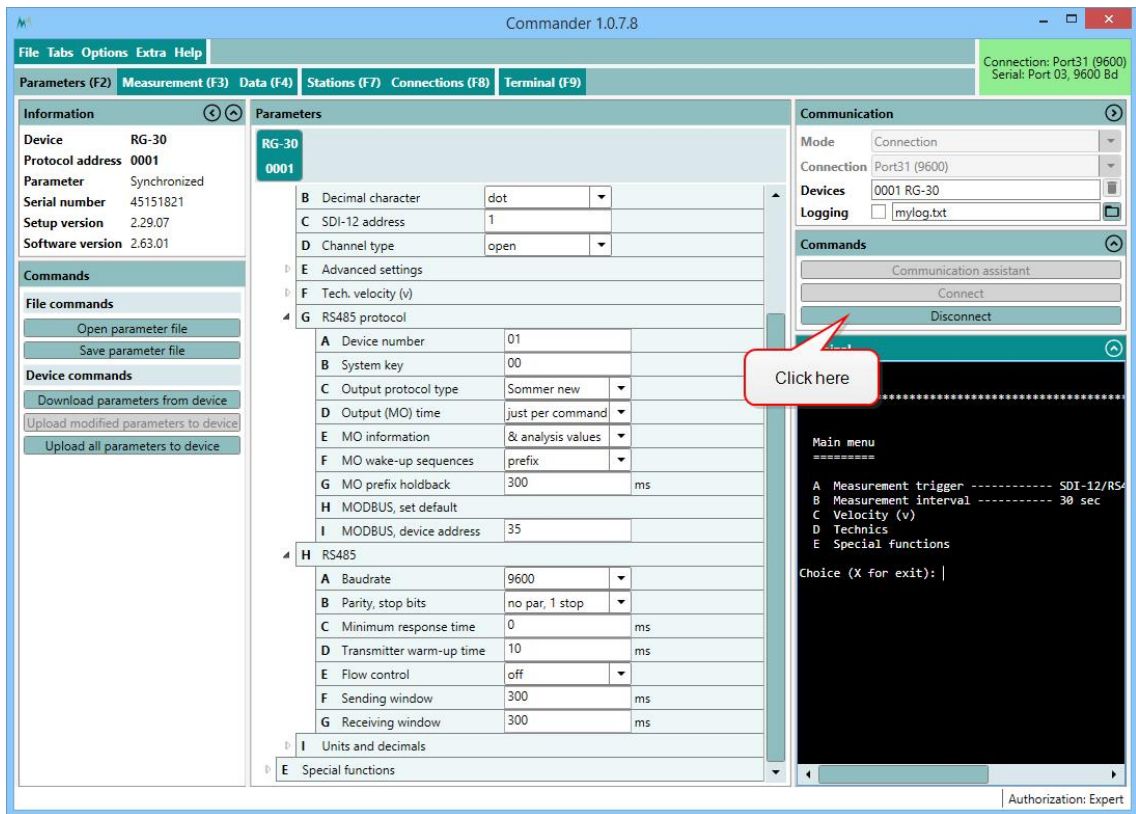

NOTE

By switching communication to Modbus with **MODBUS**, set default the following parameters are changed:

Parameter	Modbus setting
OP, measurement output	just per command
Output protocol (OP)	Modbus
MODBUS, device address	35
Sleep mode	Modbus, slow
Parity, stop bits	even par, 1 stop
Baud rate	19200
Flow control	off
Transmitter warm-up time	10 ms
Minimum response time	30 ms

11.5.5 How do I switch back to Sommer protocol?

Follow the instructions below to change the data output back to Sommer-protocol:



1. Open the **Connections (F8)** tab and click **New connection**.

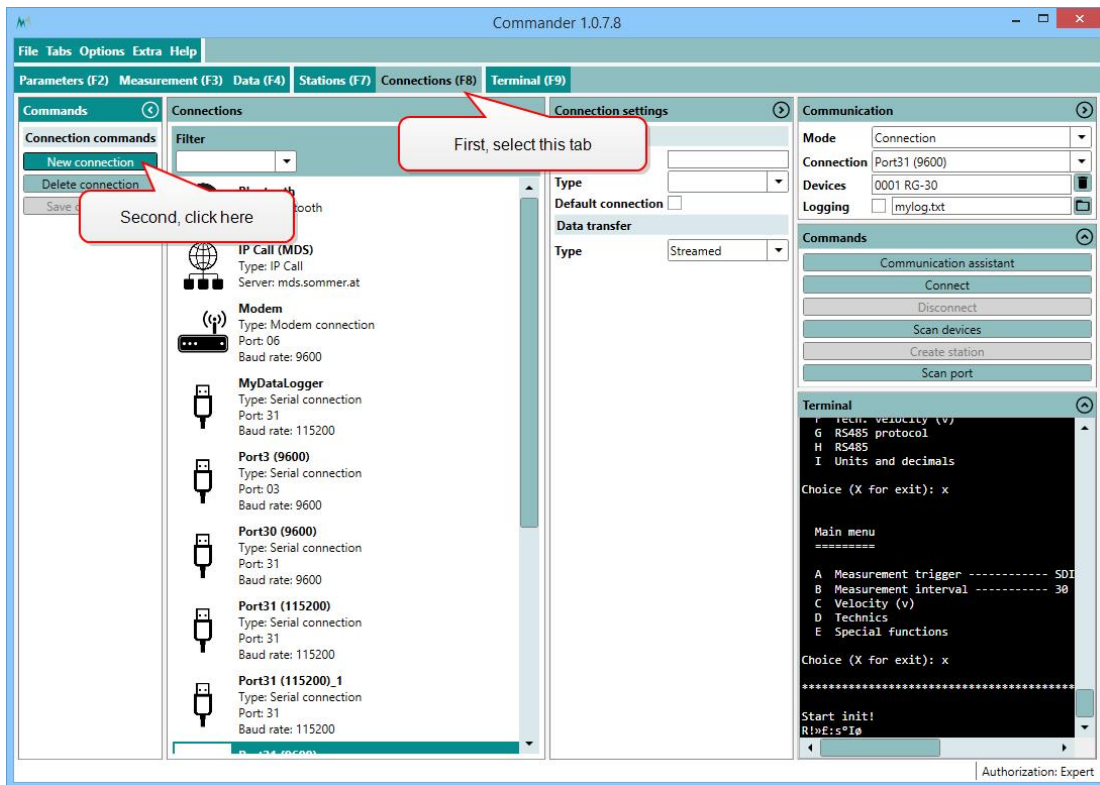

2. Enter the **Name** of the new connection. We recommend to use a meaningful name for later recognition, e.g. Modbus31 (19200) to indicate port 31 and Baud-rate 19200. Select the **Type** **Serial connection** and choose the **Port** your sensor is connected to, set the **Baud-rate** to **19200** and the **Parity/stop bits** to **Even par., 1 stop bit**.



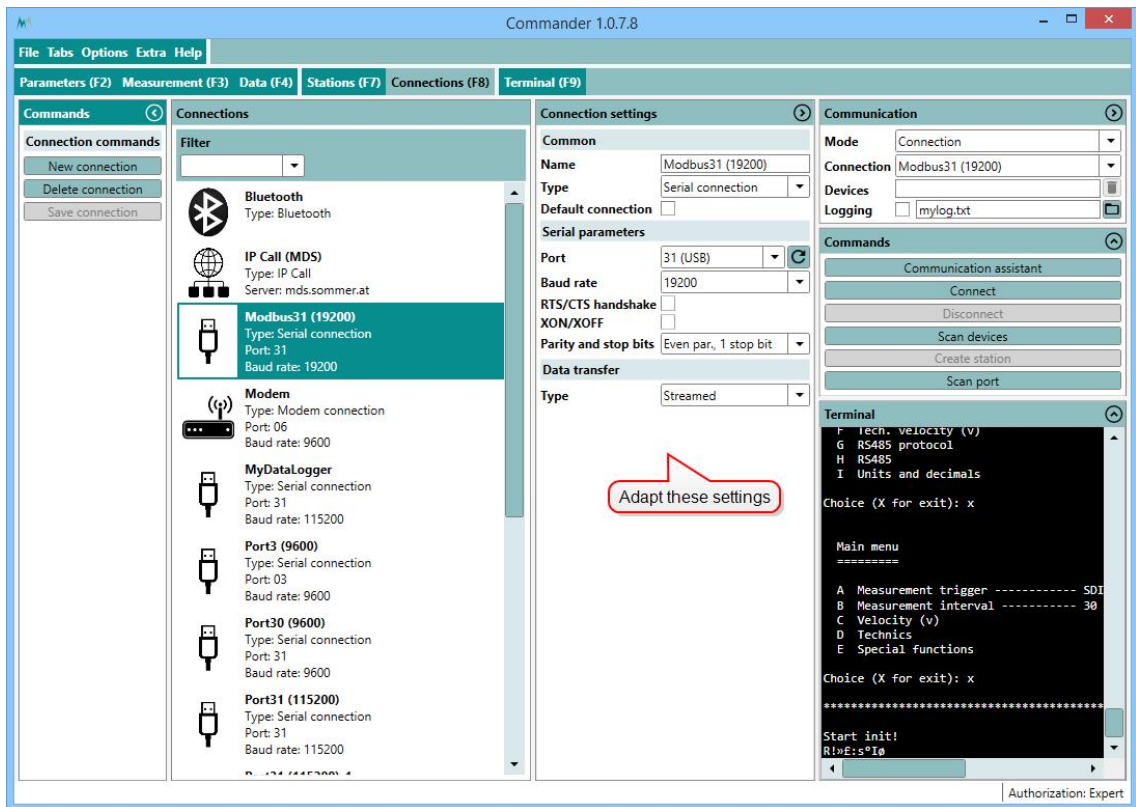

3. Click **Save connection**.
4. In the Communication window select **Mode Connection** and choose the **Connection** you have created. Then click **Connect**.



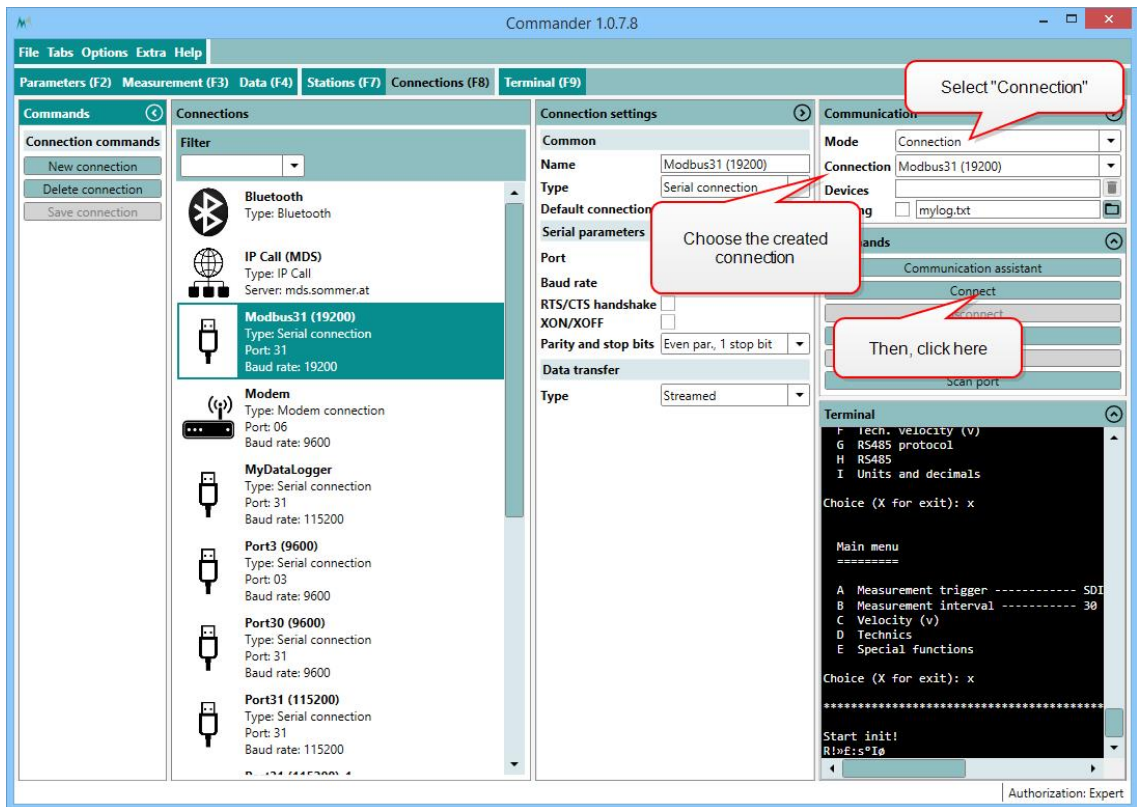

- Download the parameters and save the parameter file as described in [How do I configure it?](#).



TIP Save the parameter file for future use and to document configuration changes!

- Now, two options are available to revert communication back to the Sommer-protocol:
 - If a parameter file is available that has the Sommer-protocol enabled, the file can be loaded by clicking [Open parameter file](#), selecting the respective file and uploading the parameters to the device by clicking [Upload all parameters to device](#).

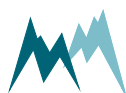

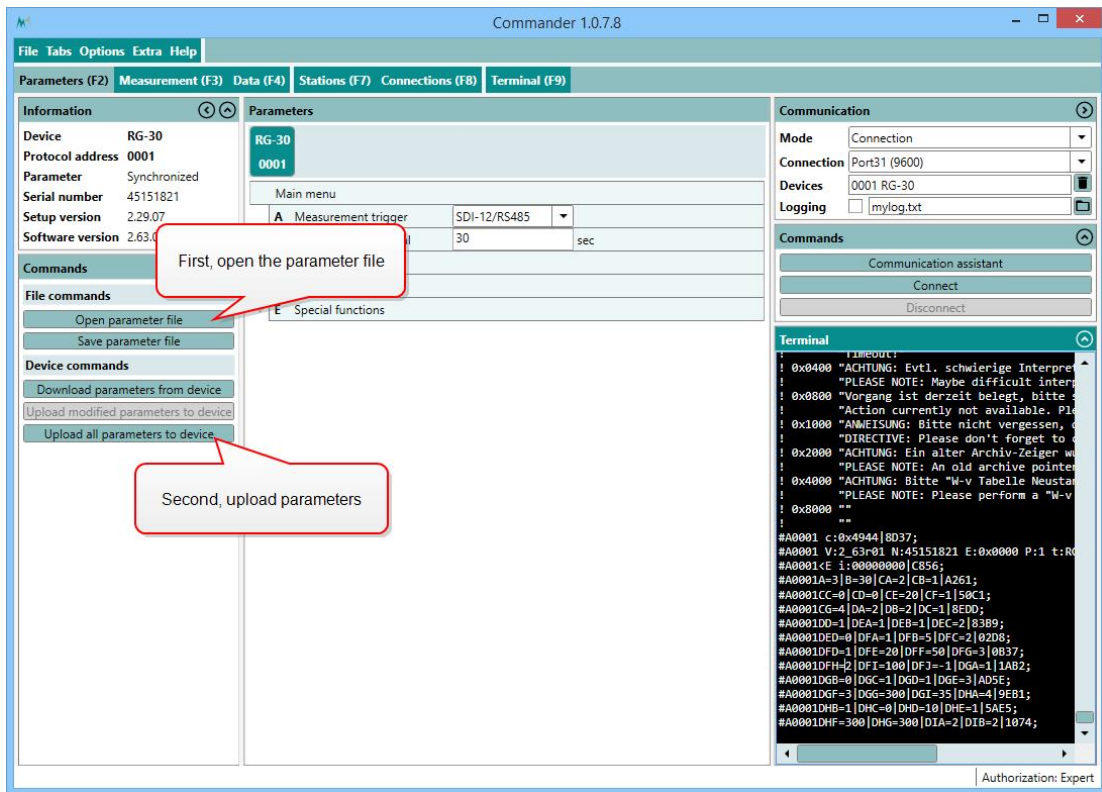

B. If no parameter file is available, the device has to be reset to its default configuration:

1. Click into the **Terminal** window and type ??? to enter the sensor-menu.

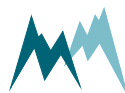
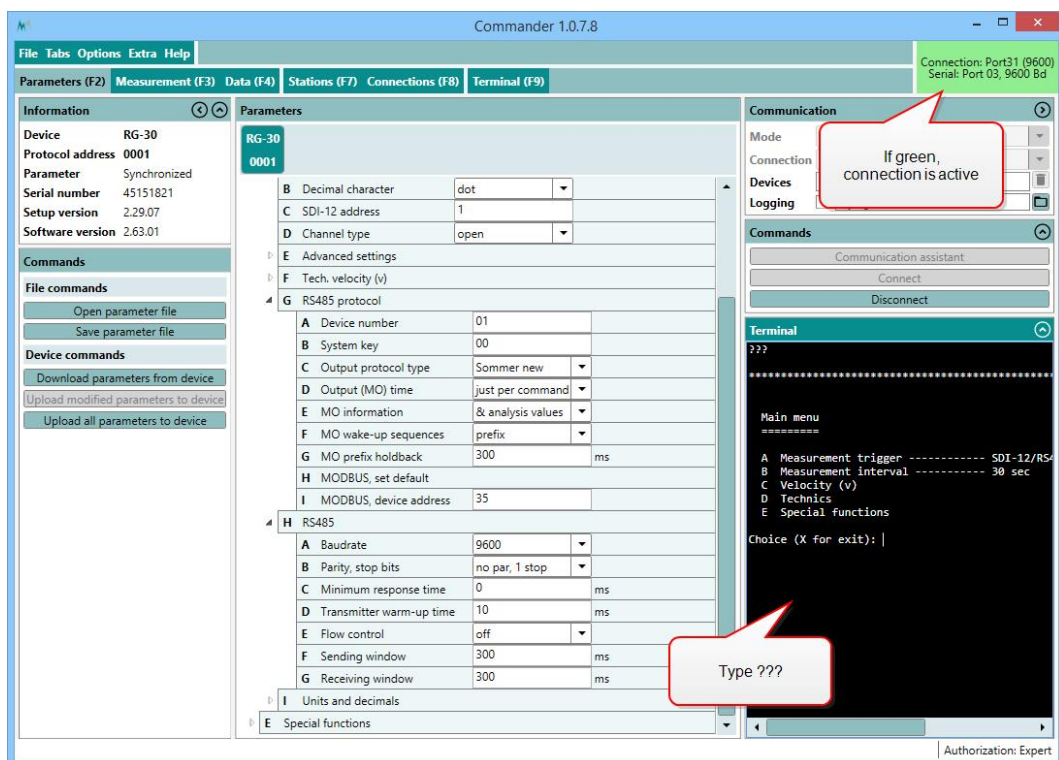

2. Navigate to [Special functions](#) and select [Set factory default...](#)
3. Acknowledge the safety-note.

```
Start up testmode: 0x07

Set factory default
^^^^^^^^^^^^^^^^^^^^

PLEASE NOTE: Please save all parameters before!
PLEASE NOTE: All user settings will be lost!
Are you sure?

(Press "RETURN" to assume)
(Press "Esc" to cancel)

=> Testmode finished!
```

4. Enter `X` until you get back to the main menu. The Sommer-sensor is now restarted and available in its initial configuration. As the connection-parameters have been changed to the default settings, the connection to the sensor is lost. Press [Disconnect](#) for completion.
7. Establish the original connection to the Sommer-sensor as described in [How do I configure it?](#).
8. Download the sensor's parameters in the [Parameters \(F2\)](#) tab, adapt the required parameters, or upload your originally saved parameter file to the IDS-20d.

11.5.6 Which commands are available?

Read measurement values

Measurement values are read from the registers of function 04 (read input registers, read only):

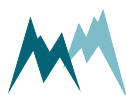

	Index	Register address	Variable	Unit / value	Bytes	Format
Test value		0	Hardcoded test value	2.7519...	4	float
Main values	01	2	Temperature	°C / F	4	float
	02	4	Humidity	%		
	03	6	Dew point	°C / F		
	04	8	Relay A	0 / 1		
	05	10	Relay B	0 / 1		
	06	12	Relay function	0 / 1		
	07	14	Sensor 1, Ice	mm		
	08	16	Sensor 1, Water	mm		
	09	18	Sensor 1, Ice rate	mm/h		
	10	20	Sensor 1, Temperature	°C / F		
	11	22	Sensor 1, Direction	°		
	12	24	Sensor 1, Direction value	-		
	13	26	Sensor 2, Ice	mm		
	14	28	Sensor 2, Water	mm		
	15	30	Sensor 2, Ice rate	mm/h		
	16	32	Sensor 2, Temperature	°C / F		
	17	34	Sensor 2, Direction	°		
	18	36	Sensor 2, Direction value	-		

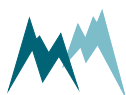

	Index	Register address	Variable	Unit / value	Bytes	Format
Special values	19	38	Relay A, counter	-	4	float
	20	40	Relay A, time	h		
	21	42	Relay B, counter	-		
	22	44	Relay B, time	h		
	23	46	Heating current	A		
	24	48	Supply Voltage	V		
	25	50	Exception code	-		

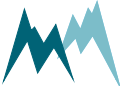

	Index	Register address	Variable	Unit / value	Bytes	Format
Analysis values	26	52	Sensor 1, Measurement phase	-	4	float
	27	54	Sensor 1, Ice raw	mm		
	28	56	Sensor 1, C P1 LF	pF		
	29	58	Sensor 1, C P1 HF	pF		
	30	60	Sensor 1, C P2 LF	pF		
	31	62	Sensor 1, C P2 HF	pF		
	32	64	Sensor 1, C P3 LF	pF		
	33	66	Sensor 1, C P3 HF	pF		
	34	68	Sensor 1, P P1 LF	°		
	35	70	Sensor 1, P P1 HF	°		
	36	72	Sensor 1, P P2 LF	°		
	37	74	Sensor 1, P P2 HF	°		
	38	76	Sensor 1, P P3 LF	°		
	39	78	Sensor 1, P P3 HF	°		
	40	80	Sensor 2, Measurement phase	-		
	41	82	Sensor 2, Ice raw	mm		
	42	84	Sensor 2, C P1 LF	pF		
	43	86	Sensor 2, C P1 HF	pF		
	44	88	Sensor 2, C P2 LF	pF		
	45	90	Sensor 2, C P2 HF	pF		



	Index	Register address	Variable	Unit / value	Bytes	Format
	46	92	Sensor 2, C P3 LF	pF		
	47	94	Sensor 2, C P3 HF	pF		
	48	96	Sensor 2, P P1 LF	°		
	49	98	Sensor 2, P P1 HF	°		
	50	100	Sensor 2, P P2 LF	°		
	51	102	Sensor 2, P P2 HF	°		
	52	104	Sensor 2, P P3 LF	°		
	53	106	Sensor 2, P P3 HF	°		
Device info	-	65533	Device type and configuration	320X	2	unsigned int
	-	65534	Software version	XYZZZ	2	unsigned int
	-	65535	Modbus implementation version	10100	2	unsigned int

Write single registers and read holding registers

Some RS-485 port settings can be written to the registers of function 06 (write single registers) or read from the registers of function 03 (read holding registers):

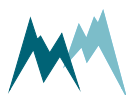

	Register address	Variable	Range	Bytes	Format
Config values	0	Modbus default ¹	0 - 1...read 1...write	2	unsigned int
	1	Modbus device address	1 to 247		
	2	RS-485 baud rate	0...1200 baud 1...2400 baud 2...4800 baud 3...9600 baud 4...19200 baud 5...38400 baud 6...57600 baud 7...115200 baud		
	3	RS-485 parity/ stop bits	0...no parity, 1 stop bit 1...no parity, 2 stop bits 2...even parity, 1 stop bit 3...odd parity, 1 stop bit		

Table 17: Function 06 and Function 03 to read and write configuration values

Report slave ID

The Modbus function 17 (report slave ID, read only) can be used to read basic information of the IDS-20d. The following example shows the response of function 17 of a RG-30 sensor, which is received in hex-format:



EXAMPLE 23 11 26 53 FF 27 74 20 53 6F 6D 6D 65 72
20 20 52 47 2D 33 30 20 20 20 32 5F 37 31 72 30 31
20 34 35 31 35 31 38 32 31 00 BB D4

¹Writing "1" sets the Modbus default settings.

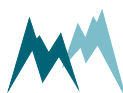

			Example	
	Content	Length (Bytes)	HEX-value	Decimal, ASCII
PDU ¹ response	Slave address	1	23	35
	Function code	1	11	17
	Number of bytes (excl. slave-address, function code, NUL and CRC)	1	26	38
	Slave ID	1	53	"S"
	Run status (0=inactive; FF=active)	1	FF	255
	Modbus implementation version	2	27 74	10100
	Separator	1	20	" "
	Vendor string	7	53 6F 6D 6D 65 72 20	"Sommer "
	Separator	1	20	" "
	Device configuration	7	52 47 2D 33 30 20 20	"RG-30 "
	Separator	1	20	" "
	Software version	7	32 5F 37 31 72 30 31	2_71r01
	Separator	1	20	" "
	Serial number	8	34 35 31 35 31 38 32 31	45151821
	NUL	1	00	
CRC	2	BB D4		

Table 18: Function 17 to report slave ID

¹Protocol Data Unit

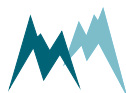

11.5.7 PLC integration

The IDS-20d can be integrated into a PLC system as a slave device. It supports the PROFIBUS, PROFINET, EtherCAT and CANopen protocols. This requires an additional serial converter, e.g. Anybus Communicator.

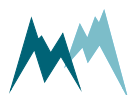

12 Parameter definitions

A	Relay A	92
B	Relay B	93
C	Sensor tests	95
D	Technics	95
E	Special functions	121

A Relay A

A-A	Output value	92
A-B	Sensor choice	92
A-C	Turn off delay	92
A-D	Ice limit	93
A-E	Water limit	93
A-F	Ice rate limit	93
A-G	Test output	93

A-A Output value

Specifies the variable which controls the relay.

Option	Description
Off	Relay does not switch
Ice (default)	Relay is turned on if Output value exceeds specified value
Ice and ice rate	Relay is turned on if Output value and Output value exceed specified values
Water	Relay is turned on if Output value exceed specified value

A-B Sensor choice

The sensor for which the limit value is monitored.

A-C Turn off delay

The time relay is kept energized after the monitored variable falls below the limit value again.



Unit	sec	seconds
Value range	0...65535	600 (default)

A-D Ice limit

The amount of ice accreted before the relay is switched.

Unit	mm	
Value range	0.0...9999999.9	0.5 (default)

A-E Water limit

The amount of accumulated water before the relay is switched.

Unit	mm	
Value range	0.0...9999999.9	1.999 (default)

A-F Ice rate limit

The rate at which ice accumulates before the relay is switched.

Unit	mm/h	
Value range	0...99999999	100 (default)

A-G Test output

Function to test the relay manually.

B Relay B

B-A	Output value	94
B-B	Sensor choice	94
B-C	Turn off delay	94
B-D	Ice limit	94



B-E	Water limit95
B-F	Ice rate limit95
B-G	Test output95

B-A Output value

Specifies the variable which controls the relay.

Option	Description
Off	Relay does not switch
Ice (default)	Relay is turned on if Output value exceeds specified value
Ice and ice rate	Relay is turned on if Output value and Output value exceed specified values
Water	Relay is turned on if Output value exceed specified value

B-B Sensor choice

The sensor for which the limit value is monitored.

B-C Turn off delay

The time relay is kept energized after the monitored variable falls below the limit value again.

Unit	sec	seconds
Value range	0...65535	600 (default)

B-D Ice limit

The amount of ice accreted before the relay is switched.

Unit	mm	
Value range	0.0...9999999.9	0.5 (default)

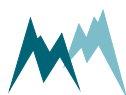

B-E Water limit

The amount of accumulated water before the relay is switched.

Unit	mm	
Value range	0.0...9999999.9	1.999 (default)

B-F Ice rate limit

The rate at which ice accumulates before the relay is switched.

Unit	mm/h	
Value range	0...999999999	100 (default)

B-G Test output

Function to test the relay manually.

C Sensor tests

C-A	Sensor S1, test heating	95
C-B	Sensor S1, test	95

C-A Sensor S1, test heating

Function to test the sensor heating. Heats the sensor for the selected duration.

C-B Sensor S1, test

Function to test the ice-sensor. Returns the currently measured capacity values. Used to verify that the sensor reads zero when dry.

D Technics

D-A	Language/Sprache	96
D-B	Decimal character	96



D-C	SDI-12 address	96
D-D	Measurement Interval	97
D-E	Sensor S1	97
D-F	Sensor S2	104
D-G	Temperature and humidity (TH)	111
D-H	Advanced settings	113
D-I	RS-485 Protocol	115
D-J	RS-485 Port	118
D-K	Units and decimals	120
D-L	Measurement table	121

D-A Language/Sprache

The menu language.

Option	Description
german/deutsch	German language
english/englisch (default)	English language

D-B Decimal character

The character used as decimal separator in the values of the settings and in serial data strings.

Option	Description
comma	-
dot (default)	-

D-C SDI-12 address

The address is a unique identifier of the sensor within a SDI-12 bus system.

Value Range	0..9, a...z, A...Z	0 (default)
-------------	--------------------	-------------

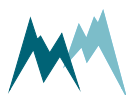

D-D Measurement Interval

An internal measurement interval can be set for the IDS-20d. If selected in menu item [Measurement trigger](#), measurements are performed in the defined interval. However, a measurement is always completed before a new one is initiated.

Unit	sec	seconds
Value range	20...10'800	60 sec (default)

D-E Sensor S1

D-E-A	Sensor type	97
D-E-B	Sensor S1, orientation	97
D-E-C	Icing verification	98
D-E-D	Limits and timer	99
D-E-E	Sensor S1 temperature	103
D-E-F	Sensor S1, test heating	104
D-E-G	Sensor S1, zero adjust	104
D-E-H	Sensor S1, test	104

D-E-A Sensor type

One of the following sensor types can be selected:

Option	Description
Cube 5 (default)	Cube 5 sensor
Rod T 80	Rod sensor 80
Custom	Reserved for custom or new sensor types

D-E-B Sensor S1, orientation

The orientation of the sensor relative to geographic north. Use the black mark on the cube sensor for northing.

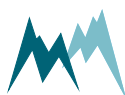

Unit	°	
Value range	-180...359	0 (default)

D-E-C Icing verification

D-E-C-A	Maximum temperature	98
D-E-C-B	Minimum humidity	98
D-E-C-C	Maximum water	98
D-E-C-D	Switch on delay	98
D-E-C-E	Temperature sensor choice	99

D-E-C-A Maximum temperature

Temperature below which icing may occur.

Unit	°C	
Value range	-99999.9...999999.9	0.5 (default)

D-E-C-B Minimum humidity

Relative humidity above which icing may occur.

Unit	-	
Value range	0.0...9999999.9	80 (default)

D-E-C-C Maximum water

Thickness of water layer below which icing may occur.

Unit	mm	
Value range	0.0...9999999.9	0.5 (default)

D-E-C-D Switch on delay

Time delay between verification of icing and actual output of icing in data string. Specifying a delay might be advisable under threshold conditions.

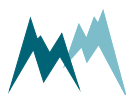

Unit	sec	
Value range	0...7200	0 (default)

D-E-C-E Temperature sensor choice

The temperature sensor used for icing verification. Select one of the following options:

Option	Description
sensor temperature (default)	The surface temperature of the IDS-20d sensor
air temperature	The air temperature of the external T/rH-sensor

D-E-D Limits and timer

D-E-D-A	Min. sup. voltage for heating	99
D-E-D-B	Ice, maximum	99
D-E-D-C	Ice, minimum	100
D-E-D-D	Water, maximum	100
D-E-D-E	Water, minimum	100
D-E-D-F	Ice rate, heating	100
D-E-D-G	Ice rate, minimum	101
D-E-D-H	Ice rate, holdtime	101
D-E-D-I	Maximum heating time	102
D-E-D-J	Subsequent heating, head	102
D-E-D-K	Subsequent heating, shaft	102
D-E-D-L	Cool down duration	102
D-E-D-M	Duration frost suppression	102
D-E-D-N	Meas. duration icing rate	103

D-E-D-A Min. sup. voltage for heating

Minimum supply voltage for sensor heating.

Unit	V	
Value range	0.00...999999.99	10 (default)

D-E-D-B Ice, maximum

Maximum ice accumulation before sensor starts heating.

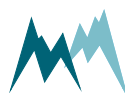

Unit	mm	
Value range	0...9999999.9	1 (default)

D-E-D-C Ice, minimum

Thickness of ice layer at which heating stops. This limit is only active in combination with [Water, minimum](#).

Unit	mm	
Value range	0...9999999.9	0.1 (default)

D-E-D-D Water, maximum

Maximum water accumulation before sensor starts heating.

Unit	mm	
Value range	1.0...9999999.9	2 (default)

D-E-D-E Water, minimum

Thickness of water layer at which heating stops. This limit is only active in combination with [Ice, minimum](#).

Unit	mm	
Value range	0.0...9999999.9	0.1 (default)

D-E-D-F Ice rate, heating

A switch to activate a sensor heating if the icing-rate drops below a specified limit. Generally, this option is used to detect individual icing-events.

If ice accumulates on the sensor above a limit value specified in [Ice limit](#), relay A and/or B close; see [Figure 14](#) for an illustration. Ice accretion may continue above this limit value, but may eventually cease, i.e. the icing rate levels off. Any further accumulation on the existing ice layer can be detected with reduced sensitivity only. Thus, it would be advantageous to continue ice-monitoring with a dry sensor surface. The “ice rate, heating” setting enables this option: If the icing rate falls below the value specified in [Ice rate, minimum](#) over the time set in [Ice rate, holdtime](#) a sensor heating is triggered. Consequently, relay A and/or B open, the sensor is defrosted and the IDS-20d is ready to detect a new icing event.

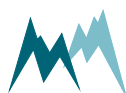

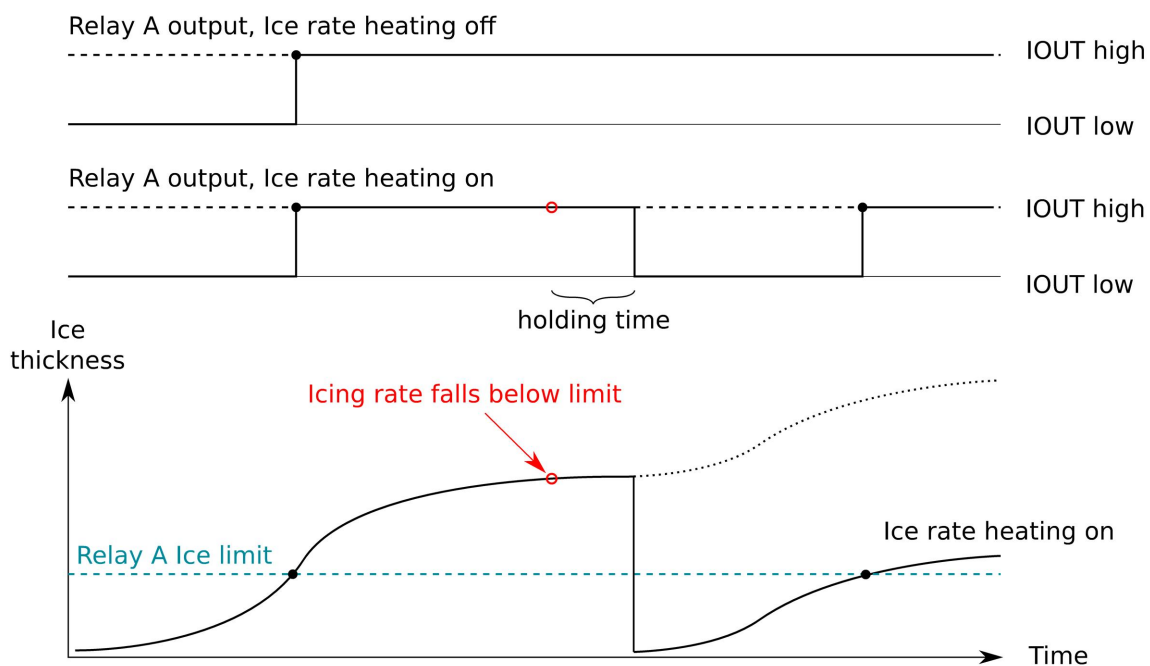

Figure 14 Behavior of Ice rate heating option

Option	Description
off	Sensor heating triggered by reduced icing rate is inactive.
on (default)	Sensor heating triggered by reduced icing rate active.

D-E-D-G Ice rate, minimum

Minimum icing rate below which a sensor heating is triggered. See [Ice rate, heating](#) for details.

Unit	mm/h	
Value range	-999999.9...9999999.9	0.5 (default)

D-E-D-H Ice rate, holdtime

Time before a sensor heating is triggered due to a low icing rate. See [Ice rate, heating](#) for details.

Unit	sec	
Value range	0...7200	600 (default)

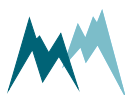

D-E-D-I Maximum heating time

Maximum heating duration for one heating cycle.

Unit	sec	
Value range	0...7200	600 (default)

D-E-D-J Subsequent heating, head

The time the sensor head is continued to be heated after a regular heating cycle.

Unit	sec	
Value range	0...1800	0 (default)

D-E-D-K Subsequent heating, shaft

The time the sensor shaft is continued to be heated after a regular heating cycle.

Unit	sec	
Value range	0...1800	120 (default)

D-E-D-L Cool down duration

Time for sensor to cool down to ambient conditions.

Unit	sec	
Value range	0...1800	180 (default)

D-E-D-M Duration frost suppression

Frost generally builds up to thin ice layers well below the [Ice, minimum](#) limit and the relay [Duration frost suppression](#) before accretion levels off. To detect individual frost events a sensor heating can be triggered after a specified time with no further ice accumulation. The sensor surface is then dry again to sense the next frost-event. [Figure 15](#) illustrates such a situation:

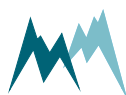

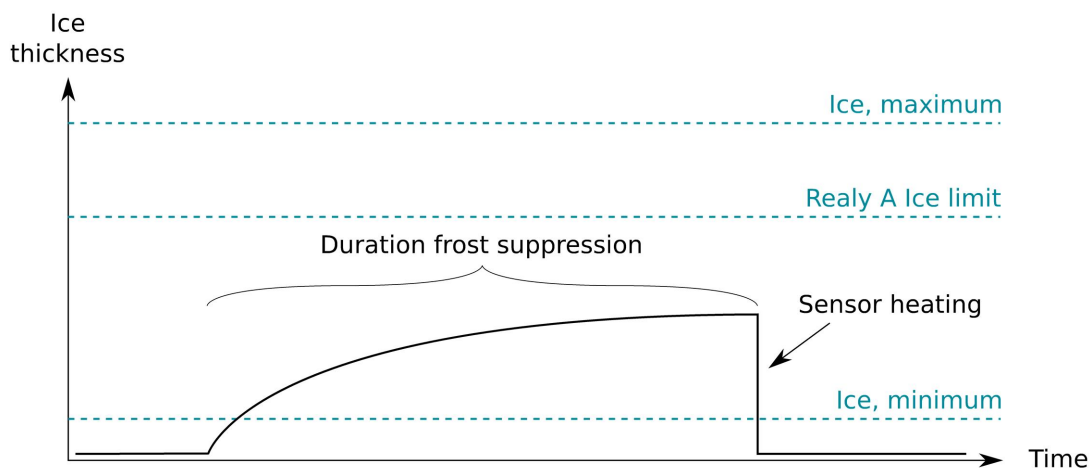

Figure 15 Duration frost suppression



ATTENTION If **Duration frost suppression** is set to **0** frost suppression is inactive.

Unit	sec	
Value range	-86400...86400	0 (default)

D-E-D-N Meas. duration icing rate

Measurement time used to determine icing rate.

Unit	sec	
Value range	0...1800	360 (default)

D-E-E Sensor S1 temperature

D-E-E-A	Temperature offset	103
D-E-E-B	Adjust temperature	104
D-E-E-C	Test temperature	104

D-E-E-A Temperature offset

Offset of the Pt-1000 temperature sensor. An offset might be required if the sensor needs to be matched to an external reference.

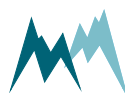

Unit	°C	
Value range	-9999.99...99999.99	0 (default)

D-E-E-B Adjust temperature

Function to adjust the measurement of the internal Pt-1000 temperature sensor. Applying this function will update the setting [Temperature offset](#).

D-E-E-C Test temperature

Function to test the internal Pt-1000 temperature sensor.

D-E-F Sensor S1, test heating

Function to test the sensor heating. Heats the sensor for the selected duration.

D-E-G Sensor S1, zero adjust

Function to reset the capacity measurements of the sensor plates. Only used during installation to compensate for any capacities introduced by the sensor cable.

D-E-H Sensor S1, test

Function to test the ice-sensor. Returns the currently measured capacity values. Used to verify that the sensor reads zero when dry.

D-F Sensor S2

D-F-A	Sensor type	104
D-F-B	Sensor S2, orientation	105
D-F-C	Icing verification	105
D-F-D	Limits and timer	106
D-F-E	Sensor S2 temperature	111
D-F-F	Sensor S2, test heating	111
D-F-G	Sensor S2, zero adjust	111
D-F-H	Sensor S2, test	111

D-F-A Sensor type

One of the following sensor types can be selected:

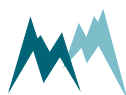

Option	Description
Cube 5 (default)	Cube 5 sensor
Rod T 80	Rod sensor 80
Custom	Reserved for custom or new sensor types

D-F-B Sensor S2, orientation

The orientation of the sensor relative to geographic north. Use the black mark on the cube sensor for northing.

Unit	°	
Value range	-180...359	0 (default)

D-F-C Icing verification

D-F-C-A	Maximum temperature	105
D-F-C-B	Minimum humidity	105
D-F-C-C	Maximum water	106
D-F-C-D	Switch on delay	106
D-F-C-E	Temperature sensor choice	106

D-F-C-A Maximum temperature

Temperature below which icing may occur.

Unit	°C	
Value range	-99999.9...999999.9	0.5 (default)

D-F-C-B Minimum humidity

Relative humidity above which icing may occur.

Unit	-	
Value range	0.0...9999999.9	80 (default)



D-F-C-C Maximum water

Thickness of water layer below which icing may occur.

Unit	mm	
Value range	0.0...9999999.9	0.5 (default)

D-F-C-D Switch on delay

Time delay between verification of icing and actual output of icing in data string. Specifying a delay might be advisable under threshold conditions.

Unit	sec	
Value range	0...7200	0 (default)

D-F-C-E Temperature sensor choice

The temperature sensor used for icing verification. Select one of the following options:

Option	Description
sensor temperature (default)	The surface temperature of the IDS-20d sensor
air temperature	The air temperature of the external T/rH-sensor

D-F-D Limits and timer

- D-F-D-A Min. sup. voltage for heating107
- D-F-D-B Ice, maximum107
- D-F-D-C Ice, minimum107
- D-F-D-D Water, maximum107
- D-F-D-E Water, minimum107
- D-F-D-F Ice rate, heating108
- D-F-D-G Ice rate, minimum109
- D-F-D-H Ice rate, holdtime109
- D-F-D-I Maximum heating time109
- D-F-D-J Subsequent heating, head109
- D-F-D-K Subsequent heating, shaft109
- D-F-D-L Cool down duration109

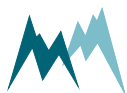

D-F-D-M	Duration frost suppression	110
D-F-D-N	Meas. duration icing rate	110

D-F-D-A Min. sup. voltage for heating

Minimum supply voltage for sensor heating.

Unit	V	
Value range	0.00...999999.99	10 (default)

D-F-D-B Ice, maximum

Maximum ice accumulation before sensor starts heating.

Unit	mm	
Value range	0...9999999.9	1 (default)

D-F-D-C Ice, minimum

Thickness of ice layer at which heating stops. This limit is only active in combination with [Water, minimum](#).

Unit	mm	
Value range	0...9999999.9	0.1 (default)

D-F-D-D Water, maximum

Maximum water accumulation before sensor starts heating.

Unit	mm	
Value range	1.0...9999999.9	2 (default)

D-F-D-E Water, minimum

Thickness of water layer at which heating stops. This limit is only active in combination with [Ice, minimum](#).

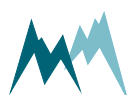

Unit	mm	
Value range	0.0...9999999.9	0.1 (default)

D-F-D-F Ice rate, heating

A switch to activate a sensor heating if the icing-rate drops below a specified limit. Generally, this option is used to detect individual icing-events.

If ice accumulates on the sensor above a limit value specified in **Ice limit**, relay A and/or B close; see **Figure 16** for an illustration. Ice accretion may continue above this limit value, but may eventually cease, i.e. the icing rate levels off. Any further accumulation on the existing ice layer can be detected with reduced sensitivity only. Thus, it would be advantageous to continue ice-monitoring with a dry sensor surface. The “ice rate, heating” setting enables this option: If the icing rate falls below the value specified in **Ice rate, minimum** over the time set in **Ice rate, holdtime** a sensor heating is triggered. Consequently, relay A and/or B open, the sensor is defrosted and the IDS-20d is ready to detect a new icing event.

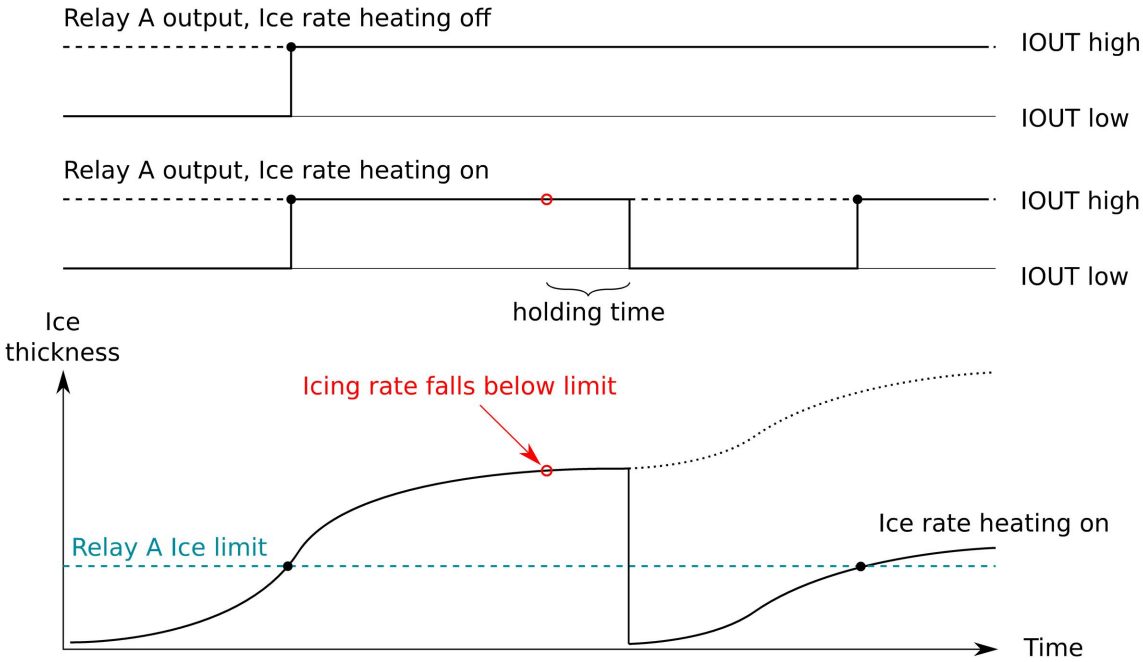

Figure 16 Behavior of Ice rate heating option

Option	Description
off	Sensor heating triggered by reduced icing rate is inactive.
on (default)	Sensor heating triggered by reduced icing rate active.



D-F-D-G Ice rate, minimum

Minimum icing rate below which a sensor heating is triggered. See [Ice rate, heating](#) for details.

Unit	mm/h	
Value range	-999999.9...9999999.9	0.5 (default)

D-F-D-H Ice rate, holdtime

Time before a sensor heating is triggered due to a low icing rate. See [Ice rate, heating](#) for details.

Unit	sec	
Value range	0...7200	600 (default)

D-F-D-I Maximum heating time

Maximum heating duration for one heating cycle.

Unit	sec	
Value range	0...7200	600 (default)

D-F-D-J Subsequent heating, head

The time the sensor head is continued to be heated after a regular heating cycle.

Unit	sec	
Value range	0...1800	0 (default)

D-F-D-K Subsequent heating, shaft

The time the sensor shaft is continued to be heated after a regular heating cycle.

Unit	sec	
Value range	0...1800	120 (default)

D-F-D-L Cool down duration

Time for sensor to cool down to ambient conditions.

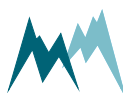

Unit	sec	
Value range	0...1800	180 (default)

D-F-D-M Duration frost suppression

Frost generally builds up to thin ice layers well below the **Ice, minimum** limit and the relay **Duration frost suppression** before accretion levels off. To detect individual frost events a sensor heating can be triggered after a specified time with no further ice accumulation. The sensor surface is then dry again to sense the next frost-event. **Figure 17** illustrates such a situation:

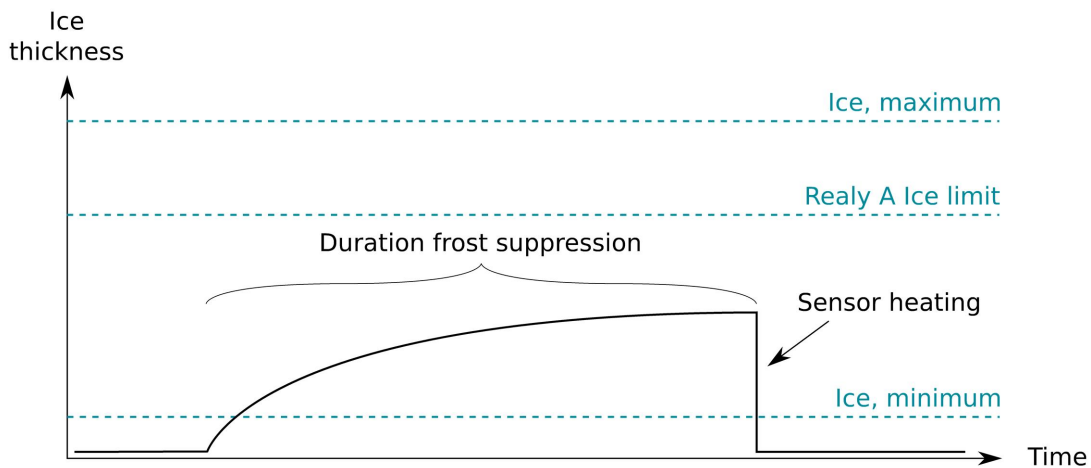



Figure 17 Duration frost suppression

 **ATTENTION** If **Duration frost suppression** is set to **0** frost suppression is inactive.

Unit	sec	
Value range	-86400...86400	0 (default)

D-F-D-N Meas. duration icing rate

Measurement time used to determine icing rate.

Unit	sec	
Value range	0...1800	360 (default)

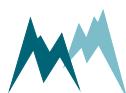

D-F-E Sensor S2 temperature

D-F-E-A	Temperature offset	111
D-F-E-B	Adjust temperature	111
D-F-E-C	Test temperature	111

D-F-E-A Temperature offset

Offset of the Pt-1000 temperature sensor. An offset might be required if the sensor needs to be matched to an external reference.

Unit	°C	
Value range	-9999.99...99999.99	0 (default)

D-F-E-B Adjust temperature

Function to adjust the measurement of the internal Pt-1000 temperature sensor. Applying this function will update the setting [Temperature offset](#).

D-F-E-C Test temperature

Function to test the internal Pt-1000 temperature sensor.

D-F-F Sensor S2, test heating

Function to test the sensor heating. Heats the sensor for the selected duration.

D-F-G Sensor S2, zero adjust

Function to reset the capacity measurements of the sensor plates. Only used during installation to compensate for any capacities introduced by the sensor cable.

D-F-H Sensor S2, test

Function to test the ice-sensor. Returns the currently measured capacity values. Used to verify that the sensor reads zero when dry.

D-G Temperature and humidity (TH)

D-G-A	Humidity offset	112
-------	-----------------------	-----



D-G-B	Adjust humidity	112
D-G-C	Test humidity	112
D-G-D	Temperature offset	112
D-G-E	Adjust temperature	112
D-G-F	Test temperature	113

D-G-A Humidity offset

Offset of the humidity of the T/rH-sensor. An offset might be required if the sensor needs to be matched to an external reference.

Unit	°C	
Value range	-999999.9...9999999.9	0.0 (default)

D-G-B Adjust humidity

Function to adjust the humidity measurement of the T/rH-sensor. Applying this function will update the setting [Humidity offset](#).

D-G-C Test humidity

Function to test the humidity measurement of the T/rH-sensor.

D-G-D Temperature offset

Offset of the temperature of the T/rH-sensor. An offset might be required if the sensor needs to be matched to an external reference.

Unit	°C	
Value range	-9999.99...99999.99	0 (default)

D-G-E Adjust temperature

Function to adjust the temperature measurement of the T/rH-sensor. Applying this function will update the setting [Temperature offset](#).

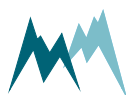

D-G-F Test temperature

Function to test the temperature measurement of the T/rH-sensor.

D-H Advanced settings

D-H-A	Sleep mode	113
D-H-B	SDI12 'M'-response	113
D-H-C	"OFF" turn off temperature	114
D-H-D	Functional switch monitoring	114
D-H-E	Functional switch at "OFF"	115
D-H-F	Sommer ID	115

D-H-A Sleep mode

Defines the behavior of the IDS-20d between two measurements, provided the measurement interval is longer than the time of the measurement itself. The following options are available:

Option	Description
MODBUS, fast	For MODBUS applications. The IDS-20d stays in normal mode. This option permits high data transmission rates, but increases power consumption.
MODBUS, slow	For MODBUS applications. The IDS-20d goes into idle mode and can be woken up by a command via the RS-485 interface with a low baud rate. This option reduces power consumption at lower data transmission rates.
Standard (default)	The IDS-20d goes into sleep mode and can be woken up by a command via the RS-485 interface only with a time delay. Option with the lowest power consumption.

D-H-B SDI12 'M'-response

Defines how an SDI-12 M-command received by the IDS-20d is answered if the requested number of measurement values exceeds 9. The following options are available:



Parameter	Description
expand address	This option should only be used with SDI-12 standard V1.0. The measurement values can be requested with the commands aD0!, aD1!,..., with a the sensor address. Max. 9 values are returned for each command.
just expand output	The M-request received by the IDS-20d is answered according to SDI-12 standard V1.3, which supports transmitting more than 9 measurement values per answer.
as at 'C' request	The M-request received by the IDS-20d is answered as if several C-requests were sent.
M1, M2, M3 split (default)	The M-request received by the IDS-20d is answered as if several Mk-commands were sent, with k depending on the number of measurement values to be transmitted (M1 returns the first 9 measurement values, M2 the second nine values, etc).

D-H-C “OFF” turn off temperature

The ambient temperature above which the IDS-20d stops performing measurements.

Unit	°C	
Value range	-99999.9...999999.9	10 (default)

D-H-D Functional switch monitoring

Sets the activity of the “OUT function” output. The following options are available:

Option	Description
just while awake	The “OUT function” output is only active while the device is active.
always active (default)	The “OUT function” output is always active.



ATTENTION If **Functional switch monitoring** is set to *just while awake*, *Sleep mode* must be set to *standard*!

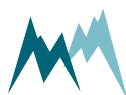

D-H-E Functional switch at “OFF”

The state of the “OUT function” output when the IDS-20d does not perform icing-measurements due to high ambient temperatures (limit set in “OFF” turn off temperature). The following options are available:

Option	Description															
regular condition (default)	<p>If the ambient temperature is above the limit value the output is set to high (1) and the relay is closed.</p> <table border="1"> <thead> <tr> <th>instrument state</th> <th>T above limit</th> <th>Functional switch state</th> </tr> </thead> <tbody> <tr> <td>OK</td> <td>no</td> <td>1</td> </tr> <tr> <td>OK</td> <td>yes</td> <td>1</td> </tr> <tr> <td>error</td> <td>no</td> <td>0</td> </tr> <tr> <td>error</td> <td>yes</td> <td>0</td> </tr> </tbody> </table>	instrument state	T above limit	Functional switch state	OK	no	1	OK	yes	1	error	no	0	error	yes	0
instrument state	T above limit	Functional switch state														
OK	no	1														
OK	yes	1														
error	no	0														
error	yes	0														
error condition	<p>If the ambient temperature is above the limit value the output is set to low (0) and the relay is opened. Thus, ambient temperatures that are too high are handled like any other error (output is set to low [0]).</p> <p>If the ambient temperature is below the limit value and the instrument operates normally the output is set to high (1).</p> <table border="1"> <thead> <tr> <th>instrument state</th> <th>T above limit</th> <th>Functional switch state</th> </tr> </thead> <tbody> <tr> <td>OK</td> <td>no</td> <td>1</td> </tr> <tr> <td>OK</td> <td>yes</td> <td>0</td> </tr> <tr> <td>error</td> <td>no</td> <td>0</td> </tr> <tr> <td>error</td> <td>yes</td> <td>0</td> </tr> </tbody> </table>	instrument state	T above limit	Functional switch state	OK	no	1	OK	yes	0	error	no	0	error	yes	0
instrument state	T above limit	Functional switch state														
OK	no	1														
OK	yes	0														
error	no	0														
error	yes	0														

D-H-F Sommer ID

The Sommer ID is used to define stations within the Commander software. The ID is preset in the device and corresponds to its serial number. SOMMER suggests not to change the ID, except if a IDS-20d device is replaced. In such a case it can be practical to change the ID of the new device to the ID of the replaced device to guarantee data consistency.

D-I RS-485 Protocol

D-I-A	Device number	116
D-I-B	System key	116
D-I-C	Output protocol (OP)	116

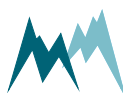

D-I-D	OP, measurement output	116
D-I-E	OP, information	117
D-I-F	OP, wake-up sequence	117
D-I-G	OP, prefix holdback	118
D-I-H	MODBUS, set default	118
D-I-I	MODBUS, device address	118

D-I-A Device number

The device number is used for the unique identification of the device in a bus system.

Value range	0...98	0 (default)
-------------	--------	-------------

D-I-B System key

The system key defines the bus system of the device. Thus, different conceptual bus systems can be separated. Interfering bus systems occur if the remote radio coverage of two measurement systems overlap. In general, the system key should be set to 00.

Value range	0...99	0 (default)
-------------	--------	-------------

D-I-C Output protocol (OP)

The type of the serial output protocol. The following options are available:

Option	Description
Sommer (default)	Sommer protocol; data values are returned with an index starting at 1
Standard	Standard protocol; data values are returned without an index
MODBUS	Modbus protocol

NOTE For MODBUS applications run **MODBUS, set default** to get the appropriate communication settings.

D-I-D OP, measurement output

Specifies the timing of the serial data output.

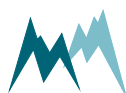

Option	Description
just per command	The output is only requested by commands via the RS-485 or SDI-12 interface.
after measurement (default)	The serial data output is performed automatically right after each measurement.
pos. TRIG slope	The output is triggered by a positive edge of a control signal applied to the trigger input.

D-I-E OP, information

The main measurement values are always included in the data output string. Additionally, special and analysis values can be included.

Option	Description
main values	Only the main values are returned.
& special values (default)	Main values and special values are returned.
& analysis values	Main, special and analysis values are returned.

D-I-F OP, wake-up sequence

Serial data can be transmitted to a recording device automatically without a request. However, many devices demand a wake-up sequence before they can receive and process data. The IDS-20d has the option to send a sync sequence and a prefix before data are transmitted (see [Waking-up a connected data logger](#)). The following options are available:

Option	Description
off	No wake-up sequence
sync	The sync sequence UU~?~? is sent before the output string.
prefix (default)	A blank with a time delay is sent before the output string.
prefix & sync	A blank with a time delay and the sync sequence UU~?~? is sent before the output string.



D-I-G OP, prefix holdback

The hold-back time defines the time delay between the prefix and the data string.

Unit	ms	Milliseconds
Value range	0...5'000	300 (default)

D-I-H MODBUS, set default

Only available in terminal mode. The Modbus protocol demands a defined setting, including multiple parameters. This command sets all these parameters automatically (see [Modbus](#)).

D-I-I MODBUS, device address

Unique device address for the Modbus protocol.

Value range	1...247	35 (default)
-------------	---------	--------------

D-J RS-485 Port

D-J-A	Baud rate	118
D-J-B	Parity, stop bits	119
D-J-C	Minimum response time	119
D-J-D	Transmitter warm-up time	119
D-J-E	Flow control	119
D-J-F	Sending window	120
D-J-G	Receiving window	120

D-J-A Baud rate

The following transmission rates in bps (baud) can be selected:

- 1'200
- 2'400
- 4'800
- 9'600 (default)

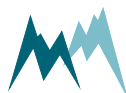

19'200

38'400

57'600

115'200

D-J-B Parity, stop bits

The following combinations of parity and stop bits can be selected:

Option	Description
no par, 1 stop (default)	No parity and 1 stop bit
no par, 2 stop	No parity and 2 stop bits
even par, 1 stop	Even parity and 1 stop bit
odd par, 1 stop	Odd parity and 1 stop bit

D-J-C Minimum response time

Setting of this parameter avoids interference of communication at the RS-485 interface. For this purpose the response to a command is delayed by the selected time. Additionally, the response is kept compact.

Unit	ms	Milliseconds
Value range	0...2'000	10 (default)

D-J-D Transmitter warm-up time

The transmitter warm-up time defines the time before data is sent.

Unit	ms	Milliseconds
Value range	0...2'000	10 (default)

D-J-E Flow control

The XOFF-XON flow control can be activated with this setting.



Option	Description
Off (default)	no flow control
XOFF-XON blocking	XOFF-XON flow control, especially adapted for half-duplex systems



ATTENTION To use spectrum mode (View spectral distribution) set **Flow control** to *XOFF-XON blocking*. This enables a return to normal mode at any time.

D-J-F Sending window

If XON-XOFF flow control is activated data are transmitted in blocks with the defined length.

Unit	ms	Milliseconds
Value range	200...5'000	300 (default)

D-J-G Receiving window

If XON-XOFF flow control is activated transmission of blocks is delayed by the specified time.

D-K Units and decimals

D-K-A	Temperature, unit	120
D-K-B	Temperature, decimals	121

D-K-A Temperature, unit

The following units of the air temperature can be selected:

Option	Description
°C (default)	Degrees Celsius
°F	Fahrenheit

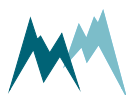

D-K-B Temperature, decimals

The number of decimal places for the measured air temperature.

Value range	0...6	2 (default)
-------------	-------	-------------

D-L Measurement table

Lists all measured variables with their units (see [Serial communication](#)).

E Special functions

E-A	Relay, reset counters	121
E-B	Relay, simulate outputs	121
E-C	Device status	122
E-D	View setup	122
E-E	Set factory default	122
E-F	Temp. load factory default	122
E-G	Relaunch program	122

E-A Relay, reset counters

Resets the relay counters.

E-B Relay, simulate outputs

Only available in terminal mode. This function is primarily used for remote system testing and can be triggered by the test input on pin 5 (see for details). It offers two options:

1. If option **1** is selected or the trigger signal on pin 5 is set high the following tasks are performed in sequence:
 - a. Relay A is closed and the sensor heating (head and shaft) is turned on for 60 sec (if sensor 1 is active)
 - b. Relay B is closed and the sensor heating (head and shaft) is turned on for 60 sec (if sensor 2 is active)
2. If option **2** is selected or the trigger signal on pin 5 is set high for more than 10 sec the tasks in option **1** are performed and the relay counters are reset.

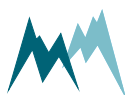

E-C Device status

Displays information about the sensor and the software version.

E-D View setup

All parameters of the IDS-20d are listed in the terminal window.

E-E Set factory default

All parameters are reset to factory defaults. Only available in terminal-mode.

E-F Temp. load factory default

Loads factory default values temporarily. Only available in terminal mode.

E-G Relaunch program

The device is restarted. Powering the sensor off and on again is equivalent.

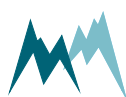

Appendix A Measurement phases

The measurement phase describes the status of the IDS-20d sensors. It is returned with the analysis values at indices 26 and 40 and has the following format:

AA . BC

The labels are coded as follows:

Label	Description
AA	Sensor status, see Sensor status
B	Icing verification result of sensor 2, see Icing verification results
C	Icing verification result of sensor 1, see Icing verification results



EXAMPLE

4 . 00	Cube 5 sensor is heating Icing-criteria for both sensors are satisfied
2 . 04	Cube 5 sensor is cooling down Icing-criteria of Rod T 80 sensor are satisfied Temperature of Cube 5 sensor is too high
0 . 44	Both sensors are in normal measurement mode Temperature of both sensors is too high
0 . 00	Both sensors are in normal measurement mode Icing-criteria for both sensors are satisfied

A.1 Sensor status

The sensor status **AA** can take the values listed in [Sensor status](#).

A.2 Icing verification

The IDS-20d uses the prevailing environmental conditions to verify the icing measured by the ice-sensors. Ice can only accrete on a sensor surface if the following conditions are satisfied:

- The sensor surface temperature must be below the limit specified in [Maximum temperature](#).
- The relative humidity must exceed the limit value specified in [Minimum humidity](#).
- The water content on the sensor surface must be below the limit value specified in [Maximum water](#).

The icing verification values B and C can take the values listed in [Icing verification results](#).

Value	Description	Comment
-1	Measurements are off	Above a specified ambient temperature the IDS-20d does not perform any icing-measurements.
0	Measurement active	Normal measurement mode
1	Determination of icing rate	Determines icing rate after cool down
2	Cool down, waiting time	After a heating cycle the sensor cools down to ambient temperature.
3	Subsequent heating	Sensor is heated after heating phase 4, 5 or 6 to ensure that the surface is completely dry.
4	Heating triggered by Ice, maximum	Sensor exceeds Ice, maximum value. Heating is on until ice and water layer thickness fall below Ice, minimum and Water, minimum or Maximum heating time has elapsed.
5	Heating triggered by Water, maximum	Sensor exceeds Water, maximum value. Heating is on until ice and water layer thickness fall below Ice, minimum and Water, minimum or Maximum heating time has elapsed.
6	Heating triggered by Ice rate, minimum	Icing rate falls below Ice rate, minimum . Heating is on until ice and water layer thickness fall below Ice, minimum and Water, minimum or Maximum heating time has elapsed.
14	Heating triggered by frost suppression, ice	Sensor exceeds Ice, minimum , stays below Ice limit of relay A or B and exceeds time limit of Duration frost suppression . Heating is on until ice and water layer thickness fall below Ice, minimum and Water, minimum or Maximum heating time has elapsed.
15	Heating triggered by frost suppression, water	Sensor exceeds Water, minimum , stays below Water limit of relay A or B and exceeds time limit of Duration frost suppression . Heating is on until water layer thickness fall below Water, minimum or Maximum heating time has elapsed.

Table 1: Sensor status

Value	Description		
0	all icing-criteria are satisfied		
1	water content too high		
2		relative humidity too low	
3	water content too high	relative humidity too low	
4			sensor temperature too high
5	water content too high		sensor temperature too high
6		relative humidity too low	sensor temperature too high
7	water content too high	relative humidity too low	sensor temperature too high
8	Switch on delay elapses		

Table 2: Icing verification results

Glossary

M

Modbus

A serial communications protocol for connecting industrial electronic devices.

R

RS-485

A standard defining the signal transmission in serial communication systems.

S

SDI-12

Asynchronous serial communications protocol for intelligent sensors (Serial Digital Interface at 1200 baud)

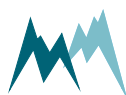

Index

M

Modbus 17, 19, 43, 73-74, 88, 116, 118

R

RS-485 17, 19, 30, 52-55, 66, 74, 88, 113,
115, 117-119

S

SDI-12 17, 19, 30, 54, 68-70, 76, 96, 113,
117

