

MRL-7, MRL-7B, MRL-70, MRL-7-GPS, MRL-7B-GPS

Data logger

Manual

Setup version 2.14 (Firmware 1.34)

28 April, 2020



Sommer Messtechnik

All rights reserved.

The Copyrights for this manual are exclusively owned by

Sommer Messtechnik
6842 Koblach
Austria

This manual or parts of it may only be copied or passed on to third parties with written permission of Sommer Messtechnik. This applies to printed as well as digital issues of this manual.



Sommer Messtechnik
Strassenhäuser 27
6842 Koblach
Austria
www.sommer.at
E office@sommer.at
T +43 5523 55989
F +43 5523 55989-19

Validity

This manual applies to the Data logger with the setup version 2.14, including all its subversions.

Created: 19 Sept, 2018

Last update: 28 April, 2020

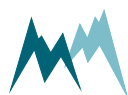

EU conformity



This product is in conformity with the following standards:

EMC	2014/30/EU	EN 301 489-1 V1.9.2
LVD	2014/35/EU	EN 62311:2008
		EN 62368-1:2014
RoHS II	2011/65/EU	
RoHS III	2015/863/EU	

Feedback

Should you come across any error in this manual, or if you miss information to handle and operate the MRL-7 we are very grateful for your feedback to office@sommer.at.



Safety information

Please read this manual carefully before installing or operating this equipment. Non-compliance with the instructions given in this manual can result in failure or damage of the equipment or may put people at risk by injuries through electrical or mechanic impact.

- Installation and electrical connections must be carried out by qualified personnel familiar with the applicable regulations and standards.
- Do not perform any installations in bad weather conditions, e.g. thunderstorms.
- Maintenance and repair must be performed by trained personnel or an engineer of Sommer Messtechnik. Only replacement parts supplied by Sommer Messtechnik should be used for repairs.
- Make sure that NO power is connected to the equipment during installation and wiring.
- Only use a power supply that complies with the power rating specified for this equipment.
- Keep equipment dry during wiring and maintenance.
- If applicable, it is recommended to use accessories of Sommer Messtechnik with this equipment.

Disposal

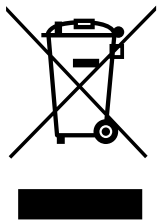

After this device has reached the end of its lifetime, it must not be disposed of with household waste! Instead, dispose of the device by returning it to a designated collection point for the recycling of waste electrical and electronic equipment.

Dispose of batteries separately!

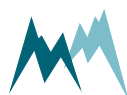

Content

1	What is the MRL-7?	13
2	Unpacking	14
3	How do I start?	15
3.1	Connect the MRL-7 to a PC	15
3.2	Configure the MRL-7	15
3.3	Connect & test sensors	16
4	What can I do with it?	17
4.1	Measurement options	18
4.1.1	Analog measurements	18
4.1.2	Counts & frequency	18
4.1.3	Serial SDI-12 data acquisition	19
4.1.4	Serial RS-485 data acquisition	19
4.1.5	GPS positioning	19
4.2	Sensor power supply	19
4.3	Communication options	20
4.3.1	Direct connection to a PC	20
4.3.2	Bluetooth	20
4.3.3	Wireless modem	21
4.4	Data storage options	21
4.4.1	Internal data storage	21
4.4.2	USB flash drive	21
4.4.3	Remote data storage	21
5	Specifications	22
6	Installation	24
6.1	Where should I install the MRL-7?	24
6.2	What do I need?	24
6.3	How do I install the MRL-7?	24
6.3.1	Mounting	24
6.3.2	Power supply	25
6.3.3	Signal cables	26
6.3.4	Surge protection	26
7	Operation	27
7.1	How do I use the keyboard?	27
7.1.1	Keyboard buttons	27
7.1.2	Display menu	27

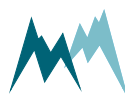

7.1.3	Activating the display	29
7.1.4	Switching off the display	29
7.1.5	Displaying the last measurement values	29
7.1.6	Replace and adjust a measurement value	29
7.1.7	Reading and changing a setting	30
7.2	How to open the data logger housing	32
7.3	How to connect a sensor	33
7.3.1	Terminals	33
7.3.2	How to use the spring clips	36
7.4	How to set the clock	38
7.5	How to copy data to a USB flash drive	38
7.5.1	Copy data since last download	38
7.5.2	Copy all data	38
8	Maintenance	40
8.1	How to insert the SIM card	40
8.2	How to do a modem test	41
8.3	How to insert the MicroSD card	42
8.4	How to replace the internal fuse	42
8.5	How to replace the internal lithium battery	43
8.6	How to replace the internal lead-acid battery (MRL-7B)	43
8.7	How to update the software	44
8.7.1	Updating the firmware	44
8.7.2	Changing the setup	46
8.8	Calibration	46
8.9	Data security	46
9	Communication	47
9.1	How to connect to the data logger	47
9.1.1	USB to RS-232 converter	47
9.1.2	Bluetooth	50
9.1.3	IP-Call	53
9.2	How to create a station	56
10	Support software Commander	58
10.1	What can I do with it?	58
10.2	How do I install it?	58
10.2.1	System requirements	58
10.2.2	Installation procedure	58

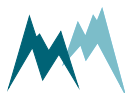

11	Configuration	64
11.1	Configuration with Commander support software	64
11.2	Configuration with a terminal program	66
11.3	What do I need to configure?	68
11.3.1	General settings	68
11.3.2	Measurement table	69
11.3.3	Messages & Actions	70
11.3.4	Totalizer reset options	70
11.3.5	Telecommunication modem	71
11.3.6	E-Mail settings	72
11.3.7	Remote access	73
11.3.8	Device clock	73
11.3.9	Camera	74
11.3.10	Data transmission	74
12	Serial communication	76
12.1	Which data do I get?	76
12.1.1	Exception values	76
12.2	RS-232	76
12.2.1	How do I configure it?	76
12.3	RS-485	77
12.3.1	What is it?	77
12.3.2	What can I do with it?	78
12.3.3	How do I wire it?	78
12.3.4	How do I configure it?	78
12.3.5	How is the output structured?	79
12.3.6	Sommer protocol	79
12.3.7	Standard protocol	81
12.3.8	Which commands are available?	83
12.3.9	Sommer CRC-16	85
13	Data acquisition examples	86
13.1	Power considerations	86
13.2	Analog measurements	86
13.2.1	Principals	87
13.2.2	Single ended voltage measurement	87
13.2.3	Differential voltage measurement	88
13.2.4	Current measurement	88
13.2.5	Resistance measurement	89
13.3	Counter & frequency measurements	89
13.3.1	Counting events	89

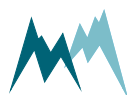

13.3.2	Frequency measurement	90
13.4	RS-485	90
13.4.1	Principles	90
13.4.2	Multiple RS-485 devices	91
13.4.3	Managing RS-485 devices with Commander	91
13.4.4	Reading data from a Sommer RS-485 device	91
13.4.5	Reading data in MIO-format	92
13.4.6	Polling data from a Sommer RS-485 device	93
13.5	SDI-12	94
13.5.1	Principles	94
13.5.2	Measurements with an SDI-12 sensor	95
13.6	How to view live data	96
13.7	How to collect data	96
13.7.1	Collecting data with Commander	96
13.8	How to view collected data	97
13.8.1	Viewing data with Commander	97
14	Parameter definitions	98
A	Station ID	98
B	Station name	98
C	Measurement Interval	98
D	Storage interval	98
E	Measurements, max. number	99
F	Aux measurements, max. number	99
G	Measurement table	99
H	Messages, table	107
I	Modem	109
I-A	Modem functionality	109
I-B	Modem config	109
I-B-A	SIM pin	110
I-B-B	Net type	110
I-B-C	Foreign operator mcc&mnc	110
I-B-D	Operator select	111
I-B-E	APN address	111
I-B-F	APN username	111
I-B-G	APN password	111
I-B-H	Custom command 1	111
I-B-I	Custom command 2	111
I-C	Data transmission 1	112
I-C-A	Target server type	112



	I-C-B	Data transmission interval	112
	I-C-C	Data transmission offset	112
	I-C-D	Content	113
	I-C-E	FTP server name	113
	I-C-F	FTP user name	113
	I-C-G	FTP password	113
	I-C-H	FTP directory	113
	I-C-I	FTP port	113
	I-C-J	FTP mode	114
	I-C-K	HTTP server name	114
	I-C-L	HTTP path	114
	I-C-M	HTTP port	114
I-D		Data transmission 2	114
I-E		Data transmission 3	114
I-F		Synchronization time	114
I-G		NTP server	115
I-H		NTP port	115
I-I		Time zone	115
I-J		Background function	115
I-K		Standby, start time	115
I-L		Standby, duration	116
I-M		IP Call server	116
I-N		IP Call port	116
I-O		IP Call interval	116
I-P		E-mail/SMTP	116
	I-P-A	E-mail/SMTP	117
	I-P-B	Sender	117
	I-P-C	Username	117
	I-P-D	Password	117
	I-P-E	Port	117
J	Technics		117
	J-A	Language/Sprache	117
	J-B	Decimal character	118
	J-C	Additional settings	118
	J-C-A	Sommer ID	118
	J-C-B	Block size, data load	118
	J-C-C	Internal low volt. Disconnect	119
	J-C-D	SommerXF starts with BOM	119
	J-C-E	Exposure lock	119
	J-C-F	LCD, Contrast	120

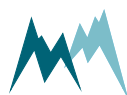

	J-C-G	LCD, Brightness	120
	J-C-H	Wind speed measurement duration	121
J-D		Additional timings	121
	J-D-A	Sum, reset time	121
	J-D-B	Occasional storage interval	121
	J-D-C	Sync date (last)	122
	J-D-D	Sync time (last)	122
	J-D-E	Min. Hold on message	122
	J-D-F	max. Hold on message	122
	J-D-G	Hold commander	122
	J-D-H	Main Switch reset	123
	J-D-I	Logger reboot time	123
J-E		Com-1 protocol	123
	J-E-A	Device number	124
	J-E-B	System key	124
	J-E-C	Output protocol (OP)	124
	J-E-D	OP, measurement output	124
	J-E-E	OP, wake-up sequence	125
	J-E-F	OP, prefix holdback	125
J-F		Com-1 port	125
	J-F-A	Baud rate	125
	J-F-B	Minimum response time	126
	J-F-C	Flow control	126
J-G		RS-485-2 Port	126
	J-G-A	Baud rate	127
	J-G-B	Parity, stop bits	127
	J-G-C	Minimum response time	127
	J-G-D	Transmitter warm-up time	128
	J-G-E	Flow control	128
	J-G-F	Sending window	128
	J-G-G	Receiving window	128
	J-G-H	Trig, polling	128
	J-G-I	Trig, timeout	129
	J-G-J	Trig, sleep while timeout	129
	J-G-K	Network scan extension	129
	J-G-L	Polling delay	130
	J-G-M	Transparency to RS485-2	130
J-H		SDI-12 bus mastering	130
	J-H-A	Max. measurement duration	130
	J-H-B	Sensor search	130

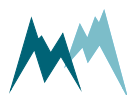

	J-H-C	Change sensor address	130
	J-H-D	Ask for sensor address	131
J-I		Analog setup	131
	J-I-A	5V sensor supply	131
	J-I-B	12V sensor supply	131
	J-I-C	Extended supply	132
	J-I-D	Switch usage	132
	J-I-E	Warm-up time	132
	J-I-F	ADC - conv. Rate	132
	J-I-G	ADC filter	133
	J-I-H	AN3 (N) type	133
	J-I-I	AN4 (D) type	134
J-J		Camera	134
	J-J-A	Switch	134
	J-J-B	Warm-up time	135
	J-J-C	Solar nightshutdown	135
	J-J-D	View	135
K		Special functions	135
	K-A	Device status	136
	K-B	View setup	136
	K-C	Continuous meas. mode (temp).	136
	K-D	Inspection, nominal values	136
	K-E	Inspection, start process	136
	K-F	Set factory default	136
	K-G	Temp. load factory default	136
	K-H	Relaunch program	137
	K-I	Replace program	137

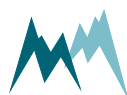

Appendix A Troubleshooting	138
A.1 Device is not powering up	138
A.2 Data logger clock displays year 2050	138
A.3 Measurement values are one hour behind	138
A.4 Commander does not find connected RS-485 sensors	139
A.5 MRL-7 receives no data from RS-485 (SBP) sensors	139
A.6 Commander cannot connect to the MRL-7 by IP call	140
A.7 Data are not transmitted	140
A.8 No e-mail was sent upon limit violation	141
A.9 I receive repeated messages after limit violation	142
A.10 Camera does not record images	142
Appendix B Escape characters	143
Appendix C DIP-switches	144

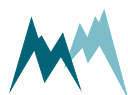

1 What is the MRL-7?

The MRL-7 is a compact data logger designed to acquire, process and store all sorts of environmental data. Its waterproof housing, integrated modem and solar charger make the MRL-7 ideal for remote, autonomous monitoring applications. The MRL-7 is compatible with all sensors offered by SOMMER Messtechnik and all third-party devices equipped with analog, SDI-12 or RS485 interface options.



Figure 1 MRL-7



2 Unpacking

When unpacking your MRL-7 sensor box please make sure that the following items are present:

Name
MRL-7 in the required version
Manual and Commander Software on USB stick

In case of missing or damaged items please contact your Sommer sales partner.

Available accessories

Art	Accessory
20181	RS-232 to USB converter cable with push-pull connector, 1.8 m
21118	Antenna for MRL-7 and DCM-3 with 2.5m cable for 2G / 3G / 4G / Bluetooth / WiFi 2.4, with SMA / M connector
20595	MRL-7 RS-485 WDR Camera 1.0mp (4mm lense)
20436	Blanking plug for unused cable glands
20434	Internal connector set
	GPS antenna for GPS-versions of MRL-7 available on request

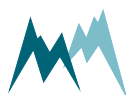

3 How do I start?

Follow the steps described below to set the basic configurations and to acquire the first measurement results.



NOTE Perform the first start-up in your lab or office before installing the equipment in the field!

3.1 Connect the MRL-7 to a PC

1. Install the Commander support software (see [How do I install it?](#))
2. Connect the RS-232 to USB converter cable to the MRL-7 and a USB port on your PC.
3. Connect a 9...28 VDC power supply to the MRL-7
4. Start the Commander software.
5. Click on [Communication assistant](#) on the right-hand side of the Commander window and follow the instructions. During this procedure the communication assistant will search for connected devices. Upon successful completion, the new connection is added to the connections list (tab [Connections \(F8\)](#)).
6. In the [Communication](#) Section at the right-hand side of the Commander window select [Mode Connection](#) and the previously created connection from the drop-down list.
7. Click [Connect](#) to establish a connection with the MRL-7. If the connection was successful a green icon is displayed at the top-right corner of the Commander window.
8. Select the tab [Parameters \(F2\)](#) and click [Download parameters from device](#) on the left side of the Commander-window. The complete parameter list is transferred from the sensor to your PC and displayed in the [Parameter](#) window.

3.2 Configure the MRL-7

1. Select language and decimal character (see [General settings](#))
2. Set the measurement and storage intervals (see [Measurement Interval](#) and [Storage interval](#))
3. Define the measurement variables (see [Measurement table](#))
4. Configure the telecommunication modem and remote access (see [Telecommunication modem](#) and [Remote access](#))
5. Set the time synchronization method (see [Device clock](#))
6. Define regular data transmission (see [Data transmission](#))

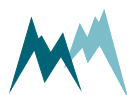

3.3 Connect & test sensors

1. Connect analog and/or digital sensors (see [What can I do with it?](#) and [Measurements & data acquisition](#))
2. Perform test measurements and verify units, slope and offset of the variables listed in the measurement table (see [Measurements & data acquisition](#))
3. Download test data (see [How to collect data](#) and [How to view collected data](#))

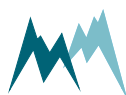

4 What can I do with it?

All data logger inputs, outputs and additional features are illustrated in Figure 2.

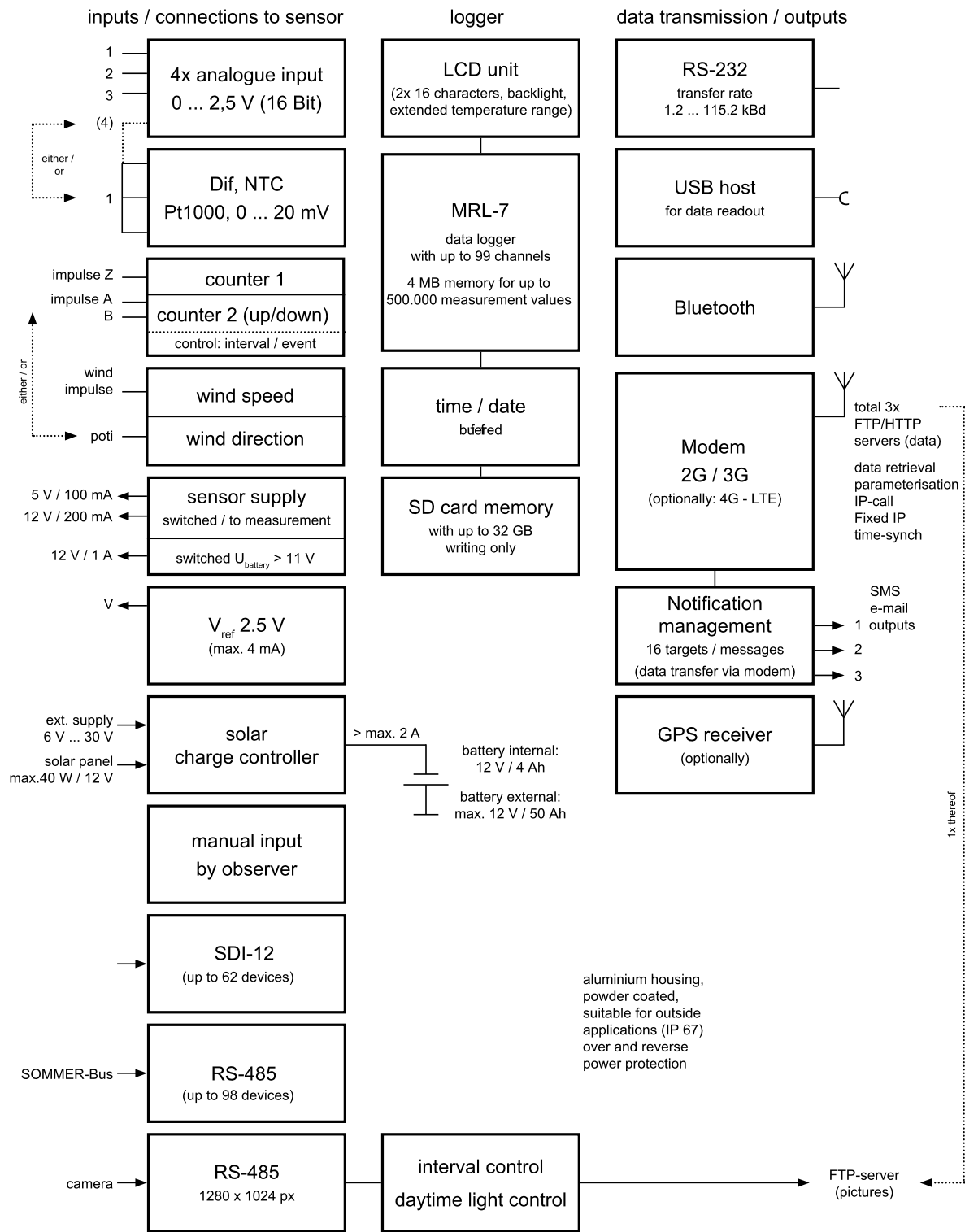

Figure 2 Data logger in- and outputs



4.1 Measurement options

The MRL-7 data logger is designed to acquire measurements of the following sensor types:

- Analog sensor with voltage and current output
- Resistive sensors, e.g. wind vanes with potentiometer output
- Sensors with frequency output, e.g. anemometers
- Sensors with pulse output, e.g. tipping bucket rain gauge
- Digital sensors using SDI-12 and Sommer RS-485 protocols

4.1.1 Analog measurements

The analog input terminals can be configured to different input signals. [Table 1](#) lists the available options.

Analog input	Measurement options
An 1	0 ... 2.5V
An 2	0 ... 2.5V
An 3	0 ... 2.5V NTC Resistance > 2k Ω
An 4	0 ... 2.5V 0 ... 0.3V Resistance > 1k25 Ω Resistance < 1k25 Ω PT1000
Wind direction / Counter 2b	Either resistance (potentiometer) or pulse counter for encoder (min. 5V); selected by DIP-switch (see Appendix C)

[Table 1](#): Analog input terminals

4.1.2 Counts & frequency

The available counter and frequency inputs are listed in [Table 2](#).



Analog input	Measurement options
Counter 1	Pulse counter (min. 5V), max. frequency 99 Hz; configurable as pull-up or pull down (see Appendix C)
Counter 2	Pulse counter (min. 5V), max. frequency 99 Hz; configurable as pull-up or pull down (see Appendix C)
Wind speed	Dedicated to wind speed only, max. frequency 1 kHz

Table 2: Counter and frequency input terminals

4.1.3 Serial SDI-12 data acquisition

The MRL-7 provides one SDI-12 port. A total of 62 SDI-12 sensors with the addresses *0...9*, *a...z* and *A...Z* can be connected.

4.1.4 Serial RS-485 data acquisition

The RS-485 port of the MRL-7 provides an interface to connect digital SOMMER sensors and can be configured to polling or pushing mode. A total of 98 Sensors with addresses *01...98* can be connected.



ATTENTION If multiple sensors are connected to the RS-485 bus and if more than one sensor is talking, data communication conflicts can occur.

4.1.5 GPS positioning

The MRL-7GPS is equipped with a GPS-receiver for moving monitoring applications, e.g. on floating buoys. The data logger can record its position to an accuracy of <100 m and send a message if it crosses a defined limit.

4.2 Sensor power supply

Sensors can be powered by the voltage supply terminals listed in [Table 3](#). Please consult the sensor manual for information on power requirements.



Output	Maximum load
5V-Out	max. 100 mA
12V-Out	max. 200 mA
2.5V Reference	4 mA
4 x Switched 12V supplies	1 x 1.10 A 3 x 0.50 A max. 2 A

Table 3: Voltage supply terminals

Output	Maximum load
5V-Out	max. 100 mA
12V-Out	max. 200 mA
2.5V Reference	4 mA
4 x Switched 12V supplies	1 x 1.10 A 3 x 0.50 A max. 2 A

Table 4: Voltage supply terminals

4.3 Communication options

4.3.1 Direct connection to a PC

Communication between the MRL-7 and a PC can be established with the supplied USB to RS-232 converter. The Commander software or any terminal editor can be used to view and edit the data logger settings. Among others, the Commander provides a [Communication assistant](#) to connect to the data logger.

4.3.2 Bluetooth

A connection between the MRL-7 and your PC can also be established via Bluetooth. If your PC is equipped with an internal or external Bluetooth-device, the [Communication assistant](#) of the

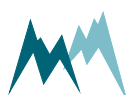

Commander software can connect to the data logger (see [Bluetooth](#) for detailed instructions).

4.3.3 Wireless modem

The MRL-7 is equipped with a wireless UMTS-modem that uses the 2G, 3G and 4G services. This allows remote connection with the data logger via IP-call, HTTP/FTP data transfer, e-mail and SMS-messages as well as time synchronization via NTP.

4.4 Data storage options

4.4.1 Internal data storage

Acquired measurement data are stored in a flash memory of 4 MB, which corresponds to approx. 500'000 values. Optionally, a MicroSD card with up to 32 GB memory can be inserted into the provided card slot. If a MicroSD card is present, data are automatically written to it once a month.

Once the internal flash memory is full, the oldest data are overwritten. No further data are written to a full MicroSD card.

4.4.2 USB flash drive

Data stored internally can be collected on a USB flash drive. After connection to the data logger and a keyboard command all data since the last collection are transferred to the USB flash drive. See [How to copy data to a USB flash drive](#) for detailed instructions.

4.4.3 Remote data storage

The acquired data stored in the data logger can be transmitted to a HTTP or FTP server. A maximum of three servers with three different transmission intervals can be configured. At the end of each interval all data and/or camera images since the last successful transmission are sent. See [Data transmission](#) for detailed instructions.



5 Specifications

Device specifications	
Power supply	11.5 ... 28 VDC; Overvoltage and reverse voltage protection Solar panel supply: max. 40 W/12 V MRL-7B: Internal lead-acid battery: 12 V/4 Ah, deep-discharge protected
Power consumption	Active: <23 mA @12V Standby: <0.6 mA @ 12V
Sensor supply	100 mA @ 5V 200 mA @ 12V 1x 1.10 A and 3 x 0.50 A @ switched supply voltage (max. 2 A in total)
Inputs	4x Analog 0...2.5 V, 16 bit (3 single ended, 1 differential) 2x Counter (one optionally as encoder) 1x Wind speed 1x Wind direction 1x RS-485 sensor or camera input 1x SDI-12 (MRL-7 as master) 1x Manual observer input (has no measurement input; only accepts an offset)
Outputs	3x Switch output (each approx. 500 mA @ supply voltage) 1x RS-232 (1200...115200 Baud, ASCII protocol) 1x RS-485 1x USB 1x Bluetooth
Memory	4 MB internal flash memory (equivalent to approx. 500'000 measurement values) 32 GB SD-card (write only)
Measurement interval	1 s ... 24 h

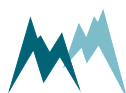

Device specifications	
Mobile modem	2G, 3G (optionally 4G) 3 FTP/HTTP servers Functions: IP call, fixed IP, time-synchronization via NTP, e-Mail and SMS messages
Operating temperature	-30 ... 60 °C (-22...140 °F), 10...95 %rH
Storage temperature, humidity	-40 ... 85 °C (-40...185 °F), 10...95 %rH
Protection rating	IP 67
Size L x W x H	MRL-7: 180 x 150 x 60 mm (7.09 x 5.91 x 2.36 inch) MRL-7B: 180 x 150 x 90 mm (7.09 x 5.91 x 3.54 inch)
Weight	MRL-7: 1260 g (2.78 lb) MRL-7B: 1610 g (3.55 lb)

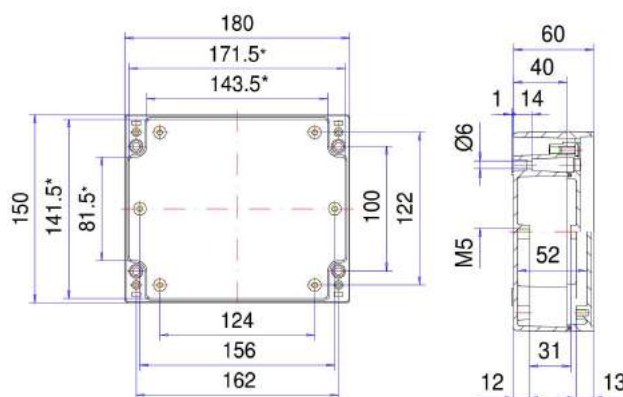

Dimensions MRL-7

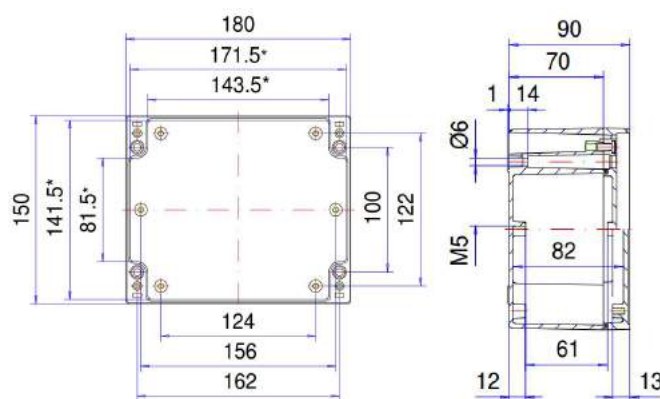

Dimensions MRL-7B

Figure 3 MRL-7 dimensions

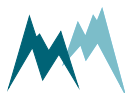

6 Installation

6.1 Where should I install the MRL-7?

The MRL-7 has been designed for applications in harsh environments. With its IP-67 protection rating it can be installed directly at the measurement facility.

If additional control and acquisition devices are used, the MRL-7 may also be mounted in a suitably sized cabinet.



ATTENTION If the MRL-7 is installed outdoors, make sure the device cover and cable glands are tightened firmly and that unused glands are replaced with watertight blanking plugs (see accessories list in [Unpacking](#)).

6.2 What do I need?

Prepare the following equipment and tools to install the MRL-7:

- 1x 5 mm Philips or flat screw driver (depending on mounting bolts)

6.3 How do I install the MRL-7?

6.3.1 Mounting

The MRL-7 can be mounted to a mounting plate of an electrical cabinet or any other back-plate with four M5 cylinder head screws with hexagon socket or M4 cylinder head screws with slot. The mounting holes can be accessed by removing the cover strips on both sides of the MRL-7 (see [6.3.1](#))

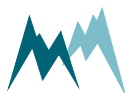

Figure 4 Mounting holes of MRL-7

6.3.2 Power supply

The MRL-7 is designed for power saving applications where mains power is not available. When actively performing measurements and acquiring data from digital sensors the data logger consumes up to 23 mA, in idle mode less than 0.6 mA at 12 VDC. Power consumption can increase considerably if the MRL-7 needs to supply connected sensors or if the communication modem is active for longer periods.

The MRL-7 can be powered with a 9...28 VDC power supply connected to the + Solar/- Solar of terminal X2 if mains power is available at the monitoring site. Alternatively, the MRL-7 can be solar powered as described in [Power supply](#).

Solar power

An integrated solar charger allows the MRL-7 to be powered by solar energy. The charger can regulate a solar panel power up to 40 W at 12 V. Follow the steps below to assemble a solar powered data logger unit:

1. Prepare appropriately dimensioned wires for connecting the solar panel and battery. For cable length up to 5 m, use 1.5-mm² copper wire. For longer cable length please consult an expert or SOMMER Messtechnik.
2. Connect a 12 V lead-acid battery with the correct polarity to the X1 terminal of the data logger. Connect a 20 A fuse to the connecting wire as shown in [Figure 5](#).



ATTENTION The MRL-7B contains a lead-acid battery with a capacity of 4 Ah. This capacity can be extended by an external battery. Make sure that the external battery is of the same type as the internal one, i.e. lead acid.

3. Ensure that the solar panel is not exposed to light and connect it with the correct polarity to the X2 terminal of the data logger.

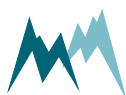

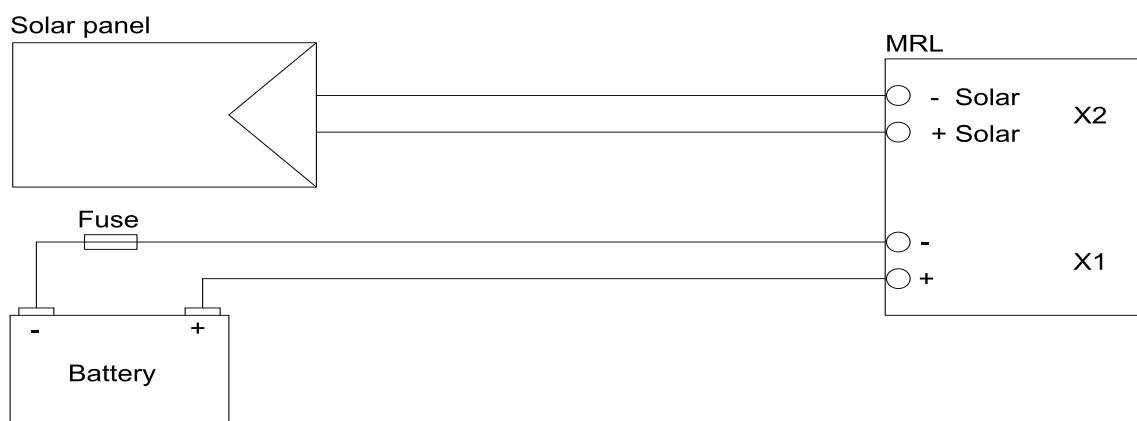

Figure 5 Wiring of a solar panel

6.3.3 Signal cables

Please consider the maximum cable lengths for the applied transmission protocol:

Protocol	Max. cable length [m]
SDI-12	60
RS-485	300

Table 5: Maximum cable lengths



NOTE Cable lengths longer than 60 m require a heavier gauge wire if the power supply drops below 11 V.

6.3.4 Surge protection





Direct and indirect lightning strikes can damage or destroy the data logger. Carefully selected and designed measurement sites reduce this risk. For proper surge protection please consult the applicable regulations in your country, an expert in lightning protection or SOMMER Messtechnik.

7 Operation

7.1 How do I use the keyboard?

7.1.1 Keyboard buttons

The keyboard on the data logger can be used to view data and to configure a range of settings. The keys have the following navigation functions:

	Exit the current menu / abort
	Move down the menu list / decrease value
	Move up the menu list / increase value
	Select a menu item / confirm / trigger measurement
	Searching USB stick / connect Bluetooth / special functions

If a Bluetooth connection is active, the message *BT active no access!* is displayed and any manual access to the data logger is denied.



ATTENTION Pressing  aborts any activity on the logger, e.g. an active Bluetooth connection, modem test mode or data download to USB.

7.1.2 Display menu

The settings and data that can be accessed by the keyboard on the data logger are listed in [Table 6](#).

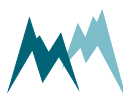

Start screen	Displays the station number, date and time.
* Measurements *	Menu containing the latest measurements of the variables specified in Measurement table .
1	Variable 1
2	Variable 2
3	Variable 3
*** Stored V ***	Menu containing the stored measurements of the variables specified in Measurement table .
01 ... 03	Variables 1 ... 3
*** Settings ***	Settings as described in Reading and changing a setting
**** Status ****	Status information
1	Station No.
2	SOMMER ID
3	Station name
4	Date
5	Time
6	Software version
7	IMSI mobile network identification
8	State of modem
9	Type of modem
10	Mobile signal quality (CSQ)

Table 6: Display menu structure



NOTE At very low ambient temperatures the LCD Display may react slowly and entered commands may not be visible instantly!

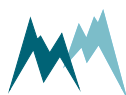

7.1.3 Activating the display

Press any key for at least one second. The data logger then displays the station number, current date and time. After four seconds of inactivity the display automatically shows the first measurement variable.

7.1.4 Switching off the display

The display is automatically switched off if no button is pressed within 10 seconds after activation. Otherwise the display is switched off after one minute of inactivity.

Alternatively, the display can be switched off by pressing  for at least two seconds. *Access and hold key!* is shown and the display is switched off by holding the key.

7.1.5 Displaying the last measurement values

After activating the data logger, press any arrow key to show the value of the first measurement variable. Press the up and down keys to navigate through the measurement list.



Press  to trigger a measurement of the selected variable.



7.1.6 Replace and adjust a measurement value

To adjust an automatically recorded value with a measurement acquired manually or with a secondary sensor perform the following steps:

1. Navigate to the required variable as described in [Displaying the last measurement values](#) above.

2. Hold  for at least two seconds.

3. Enter the access code by pressing 2x  followed by 2x .

4. Adjust the value with  and . Hold the keys to increase/decrease the value more quickly.

5. Confirm with  or abort with .

A measurement value can quickly be adjusted to zero by pressing .

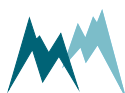















ATTENTION As long as the display is active during the ongoing session, the entered access code unlocks all system settings of the data logger!

7.1.7 Reading and changing a setting

The settings listed in [Table 1](#) can be read and changed directly on the data logger by performing the following steps:

1. Press  until you get to the main menu.
2. Navigate to `*** Settings ***` with  and  and press .
3. Enter the access code by pressing 2x  followed by 2x .
4. Navigate to the desired setting with  and  and press .
5. Adjust the value with  and . Hold the keys to increase/decrease the value more quickly.
6. Confirm with  or abort with .

Setting	Example Value	Description
Station No.	20160111	Station number
Date	06.04.2017	Current date
Time	09:26:28	Current time
Exposure lock	off	Access to measurement values
Copy all data	-	Copies all internally stored data to a USB flash drive
Erase all data	-	Erases all stored data
Continuous M	turn on	Continuous Measurement

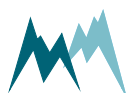

Setting	Example Value	Description
Adjust Contrast	weak	Adjusts the display contrast
Reboot Device	-	Reboots the MRL-7
Modem Testmode	-	Tests the internal mobile modem. Only available if a modem is configured.
GPS fix	-	Stores the current Lat- and Long-coordinates permanently (until next function call or data erase)

Table 7:
Accessible settings

Exposure lock

Controls the access to measurement data. If active, measurement values cannot be accessed. An exception are values of the manual observer input. Also, copying data to a USB flash drive or to another device via Bluetooth is blocked.

Copy all data

Copies all stored data to a connected USB flash drive.

Erase all data

Deletes all measurement data from the data logger.



ATTENTION Use with caution! Erased data cannot be retrieved!

Continuous M

Activates a continuous monitoring mode in which measurements are performed in the shortest possible interval. This mode is intended for testing purposes and is automatically deactivated after three minutes.

Adjust Contrast

Adjusts the brightness of the LCD-display in four levels: base, weak, medium and high.

Reboot Device

Reboots the data logger without the need to switch the power supply, e.g. after firmware updates.

Modem Testmode

Performs a modem test that includes the following tasks:

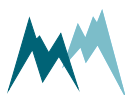

- Initialization of the modem. The SIM-card IMSI number is displayed (to freeze the display press the **DATA/BT** button).
- The signal strength of the mobile network is tested and displayed.
- The defined mobile communication actions are carried out (time synchronization, data transfer to FTP or HTTP server, activation of IP-call function).

7.2 How to open the data logger housing

The data logger has a waterproof design which requires the sensors, SIM card and MicroSD card to be connected internally.



ATTENTION To avoid the risk of electric shock disconnect the power supply before opening the housing!

To open the housing remove the cover strips on both sides of the data logger and loosen the four bolts with a Philips or flat-head screwdriver. Then, remove the lid by turning it carefully upside down. Be careful not to strain any signal wires.

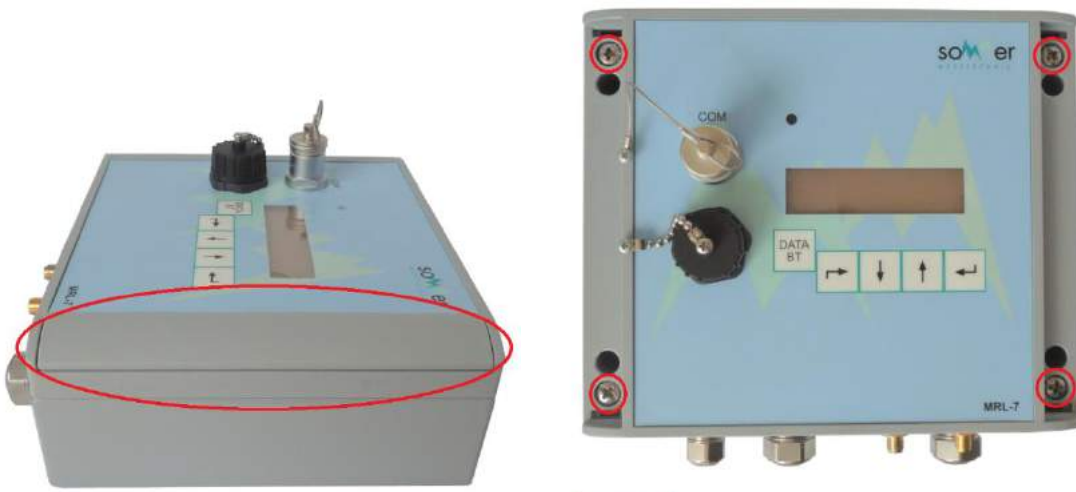

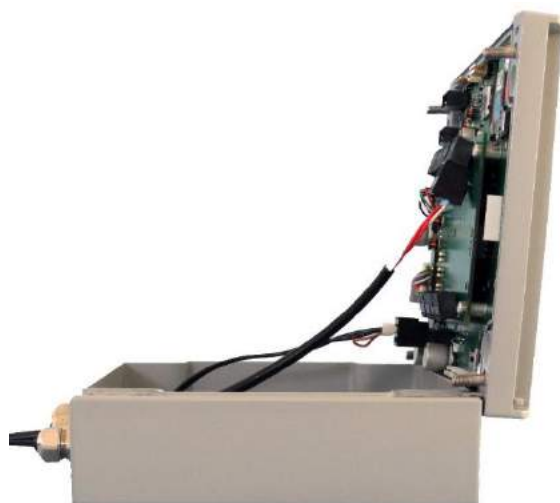

Figure 6 Open the MRL-7 housing



ATTENTION

Before closing the data logger place a desiccant bag (approx. 5g) into the housing and make sure that the rubber seal is not broken and firmly sitting in its groove!

When closing, tighten diagonally positioned screws step by step!

7.3 How to connect a sensor

To connect a sensor to the MRL-7 follow the steps described below:

1. Open the housing as describes in [How to open the data logger housing](#)
2. Feed the sensor cable through the cable gland and connect it to the specified terminal (see [Terminals](#)). For handling the spring clips see [How to use the spring clips](#).
3. After closing the data logger, carefully tighten the cable glands. When closing the data logger, pull out any excess cable without applying too much stress on the connected wires!

7.3.1 Terminals

The pin-layout of the MRL-7 is shown in [Figure 7](#) and the terminals are listed in the table below.



ATTENTION Do not connect voltages >30 V to any terminal! Excess voltages can impair the functioning of the MRL-7, destroy the device and may lead to injuries.

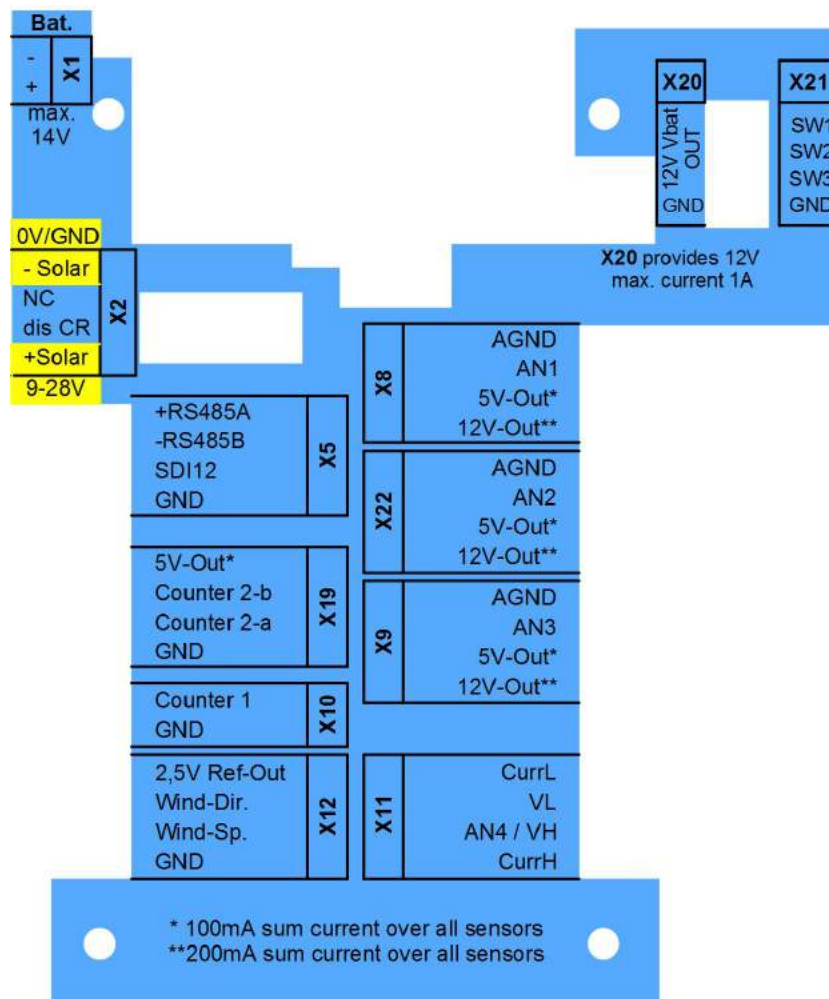
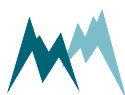

Figure 7 Connection terminals of MRL-7

Group	Pin	Description
X1	-	Battery connector (-)
	+	Battery connector (+), max. 14 V
X2	- Solar	Supply voltage (-) or solar panel connector (-)
	NC	Not connected. Do not use!
	dis CR	Disabling internal charge regulator
	+ Solar	Supply voltage (+) or solar panel connector (+)



Group	Pin	Description
X5	+ RS485A	RS-485 A
	- RS485B	RS-485 B
	SDI12	SDI-12 sensor connector
	GND	Ground
X19	5V-Out	5 V output for sensor supply (max. 100 mA) *)
	Counter 2-b	Counter 2 secondary input for encoders
	Counter 2-a	Counter 2 input
	GND	Ground
X10	Counter 1	Counter 1 input
	GND	Ground
X12	2.5V Ref-Out	2.5 V reference voltage output
	Wind-Dir.	Wind direction (potentiometer) input
	Wind-Sp.	Wind speed input
	GND	Ground
X8	AGND	Analog ground
	AN1	Analog input 1
	5V-Out	5 V output for sensor supply (max. 100 mA) *)
	12V-Out	12 V output for sensor supply (max. 200 mA) **)
X22	AGND	Analog ground
	AN2	Analog input 2
	5V-Out	5 V output for sensor supply (max. 100 mA) *)
	12V-Out	12 V output for sensor supply (max. 200 mA) **)



Group	Pin	Description
X9	AGND	Analog ground
	AN3	Analog input 3
	5V-Out	5 V output for sensor supply (max. 100 mA) *)
	12V-Out	12 V output for sensor supply (max. 200 mA) **)
X11	CurrL	Differential current input (-)
	VL	Differential voltage input (-)
	AN4 / VH	Differential voltage input (+)
	CurrH	Differential current input (+)
X20	12Vbat OUT	12 V power supply (> max. 1 A)
	12Vbat OUT	12 V power supply (> max. 1 A)
	12Vbat OUT	12 V power supply (> max. 1 A)
	GND	Ground
X21	SW1	switching output 1, 12 V
	SW2	switching output 2, 12 V
	SW3	switching output 3, 12 V
	GND	Ground
*) 100 mA total current for all sensors		
**) 200 mA total current for all sensors		

7.3.2 How to use the spring clips

To connect a sensor to the MRL-7, 2- or 4-pin spring clips as shown in [Figure 8](#) are used.

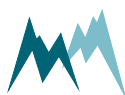
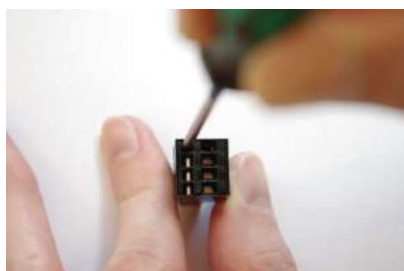



Figure 8 4-pin spring clip

After removing the spring clip from the data logger, the sensor wires are connected in the following way:



Push a 2-mm flat-head screwdriver into the spring slot to open the connection terminal.



Insert the wire into the connection terminal.



Make sure the wire is inserted down to the bottom of the connection terminal.



Pull out the screwdriver and verify that the wire is fixed firmly.

7.4 How to set the clock

The time of the MRL-7 can also be synchronized manually by clicking [Set device time](#) in the Commander [Parameters \(F2\)](#) tab.









ATTENTION If the internal lithium button cell battery is replaced, the current device time is lost and needs to be re-synchronized!

7.5 How to copy data to a USB flash drive



7.5.1 Copy data since last download

1. Insert a USB flash drive into the USB port of the MRL-7.
2. Activate the data logger.
3. Press . Data are now copied to the USB flash drive.

7.5.2 Copy all data

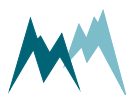
1. Activate the data logger.
2. Press  until you get to the main menu.
3. Navigate to `*** Settings ***` with  and  and press .
4. Enter the access code by pressing 2x  followed by 2x .



5. Navigate to Copy all data with  and  and press .. The data are now copied to the USB flash drive as a csv-file in the SommerXF format. The data can then be viewed with the Commander.

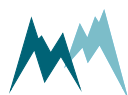

8 Maintenance

The MRL-7 does not require any special maintenance other than the occasional replacement of the supply battery of the MRL-7. The lithium button cell battery lasts approx. 10 years if the MRL-7 is not powered, and generally does not require replacement with a powered device.

8.1 How to insert the SIM card



Figure 9 Slots for SIM-card, MicroSD-card and lithium battery

The location of the SIM-card slot is shown in Figure 9. The slot only accepts Micro-SIM cards.

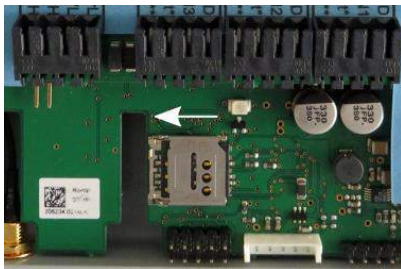

To insert a SIM-card open the housing as described in Section [How to open the data logger housing](#) and unlock the card-slot by pressing gently on the metal cover and sliding it slightly to the left



Open the cover of the slot.

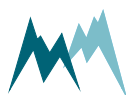



Place the SIM-card in the correct position onto the contact pins.





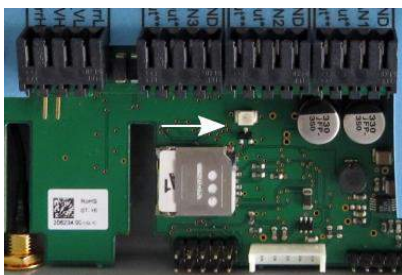





ATTENTION Insert the SIM-card in the position as shown in the image!



Close the cover and slide it back into the locked position.

8.2 How to do a modem test

Follow the instructions below to test communication via modem:

1. Activate the display of the MRL-7 by pressing one of the arrow buttons.
2. Press  until you get to the main menu, i.e. *Measurements*.
3. Navigate to *** Settings *** with  and  and press .
4. Enter the access code by pressing 2x  followed by 2x .
5. Navigate to Modem Testmode with  and  and press . The MRL-7 now performs several tests:
 1. The modem is initialized and the SIM card IMSI is displayed.
 2. The signal strength is displayed.
 3. The configured mobile communication actions are carried out: time synchronization, data transfer to the defined FTP or HTTP servers, activation of IP-call function.



ATTENTION As soon as the IMSI-number is displayed, press  to freeze the display! Note the IMSI-number; it is required for remote access via IP-call!

6. After completion, the MRL-7 displays a message whether the test was successful.

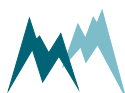

8.3 How to insert the MicroSD card

The location of the MicroSD-card slot is shown in [Figure 9](#).

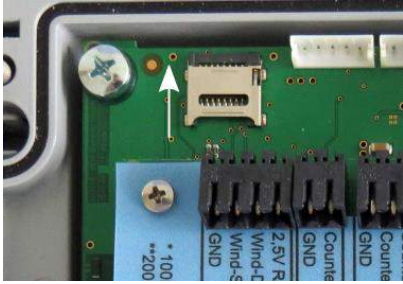

To insert a MicroSD-card open the housing as described in Section [How to open the data logger housing](#) and unlock the card-slot by pressing gently on the metal cover and sliding it slightly towards the top.



Open the cover of the slot.

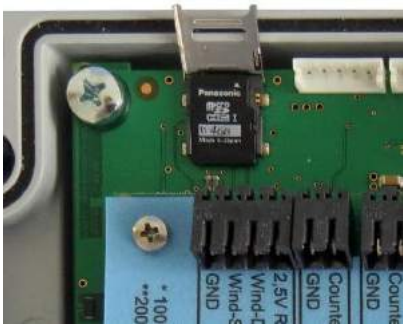

Place the MicroSD-card in the correct position onto the contact pins.

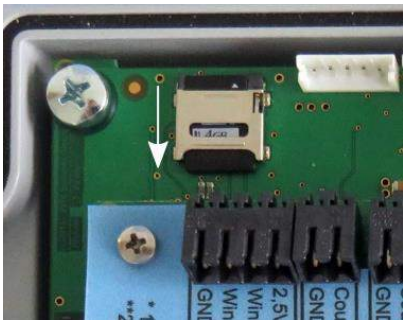

Close the cover and slide it back into the locked position.

8.4 How to replace the internal fuse

An internal fuse is mounted next to the X1 power supply terminal to protect the MRL-7 from any power surges or power failure effects.

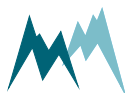

To replace the fuse, unplug any externally connected power supply and remove the cover of the MRL-7 as described in Section [How to open the data logger housing](#). Replace the fuse with a new one of type Littlefuse Mini Series 297, 2A, 32V (available, e.g. from Farnell, order-nr. 9943811).

8.5 How to replace the internal lithium battery

The 3V lithium button cell battery of type CR1225 powers the MRL-7 clock. Perform the following steps to replace the battery:

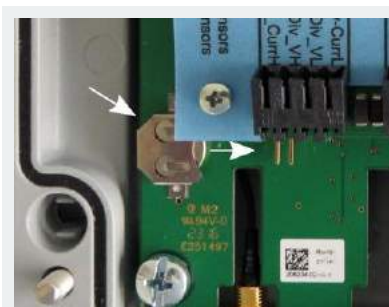

To remove the button cell battery gently push the cell out of its housing from the side using a small screwdriver.

Push the new cell with your fingers from the right side into the housing.

Set the data logger clock according to Section [How to set the clock](#).

8.6 How to replace the internal lead-acid battery (MRL-7B)



ATTENTION Unplug the internal 2A-fuse before replacing the battery!



Remove the cover of the MRL-7B as described in Section [How to open the data logger housing](#) and unplug the spring clip X1. Then, remove the cover that locks the battery in its position by loosening the two Phillips-screws.



Unplug the 2A-fuse!



Take out the battery, remove the wires and mount the new battery following the instructions in reverse.

8.7 How to update the software

The software of the MRL-7 consists of two parts: the firmware that controls the hardware and the setup-software that manages data acquisition, signal analysis, communication and much more. A new firmware is released for new data logger features or new hardware components. On the other hand, a setup-software might be provided for different applications, e.g. a setup with a high sampling and data transmission rate, or a setup with different communication settings.

8.7.1 Updating the firmware

1. Connect the MRL-7 to your PC with the USB to RS232 converter cable and make sure the data logger is powered.
2. Go to the menu [Extra](#) and select [Start Programmer](#).
3. Select the firmware file (extension [.hex](#)) provided by SOMMER Messtechnik. Make sure the file is stored on your PC and not on a USB or network drive.
4. Choose the COM-port the data logger is connected to and a Baud-rate of 57'600.
5. Perform the following three steps in short sequence: click [Program](#), unpower the data logger, wait 3...5 seconds, and repower the data logger. The firmware currently present on the data logger is now erased and the new one copied to the data logger. During the update process the pop-up window may show the following messages:

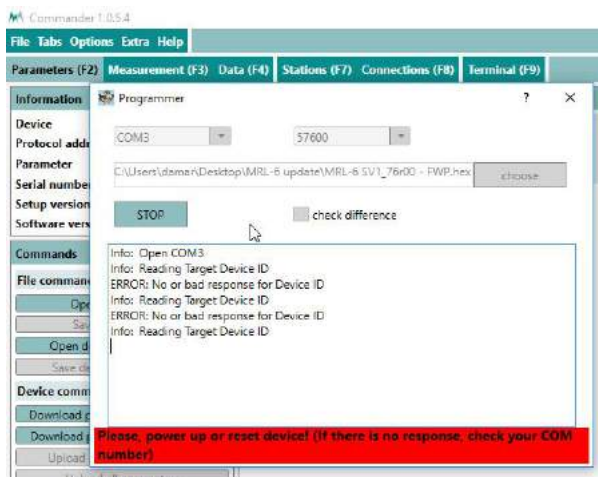

The programmer is not ready; power needs to be on.

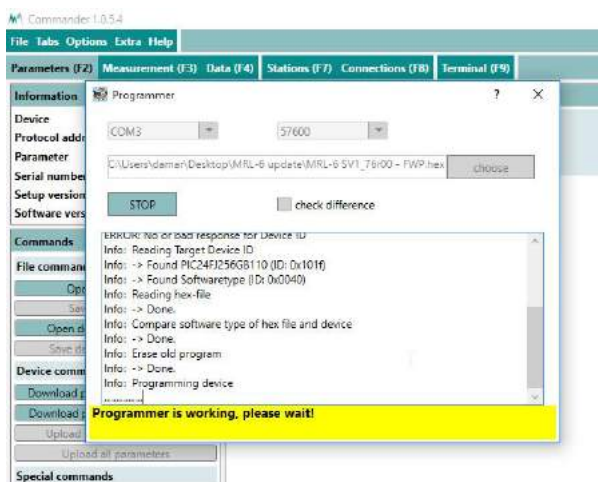

The programmer is active.

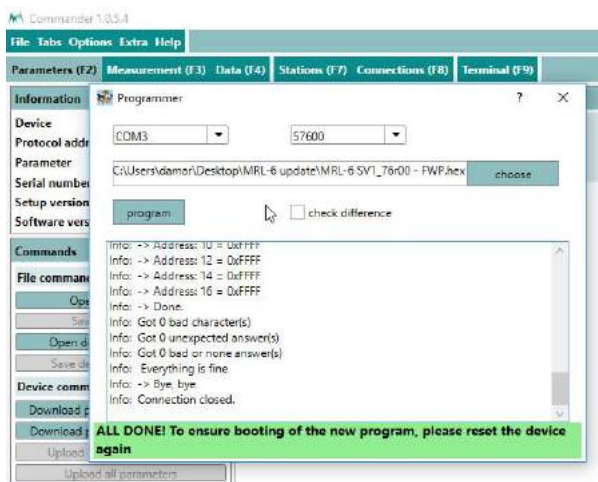

The firmware update has finished.

6. Switch off and repower the data logger again
7. Close the programmer-window as soon as the firmware update has finished and open the **Parameters (F2)** tab.

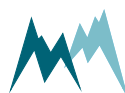

8. Click [Download parameters from device](#). The download of the new parameter list might take a few minutes. After completion the new firmware and setup versions will be displayed in the Commander.

8.7.2 Changing the setup

1. Start the Commander on your PC and connect to your MRL-7 either directly with the USB to RS232 converter cable or the optional Bluetooth connection.
2. Open the [Parameters \(F2\)](#) tab and click [Open parameter file](#). Select the required file (extension .xml or .xmla).
3. Verify the new settings and click [Upload all parameters to device](#). After completion the new settings are active on your data logger.

8.8 Calibration

Re-calibration of the AD-converters strongly depends on the handling of the data logger, its duty time and the importance of the acquired measurements. Generally, re-calibration is required after approx. 10 years of operation. Please contact Sommer Messtechnik for this service.

8.9 Data security

The issue of security may arise if the data logger is installed in sensitive areas, the acquired measurements are relevant for the safety of life and property, or intense network traffic bears the risk of data abuse.

To secure your installation and your data we recommend to follow the advice given below:

- Activate the exposure lock on your data logger (see Section [Reading and changing a setting](#))
- Restrict the time the modem is active for data transmission via IP-call (see [Standby, duration](#) and [Standby, start time](#))



9 Communication

9.1 How to connect to the data logger

Communication between the data logger and a PC can be established by using the USB to RS-232 converter cable (available as an accessory) or, via Bluetooth, and remotely via IP-Call. All these options require the Commander software. Alternatively, a terminal editor can be used to communicate with the data logger.

9.1.1 USB to RS-232 converter

Perform the following steps to set up the communication between the MRL-7 and your PC:

1. Install the Commander software on your PC.
2. Connect the provided USB to RS-232 converter to your PC. If required, install the driver of the USB to RS-232 converter.
3. Start the Commander software.
4. Click on **Communication assistant** on the right-hand side of the Commander window.

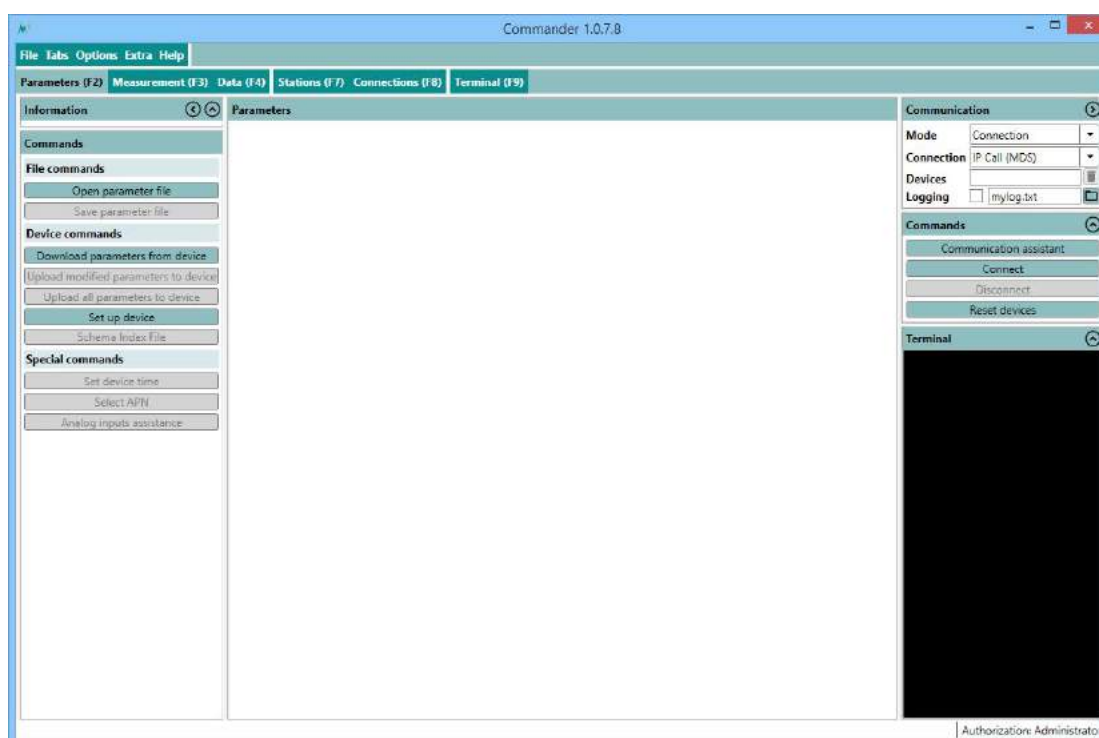

5. Select **Serial Connection** and press **Next**.

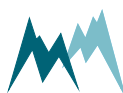

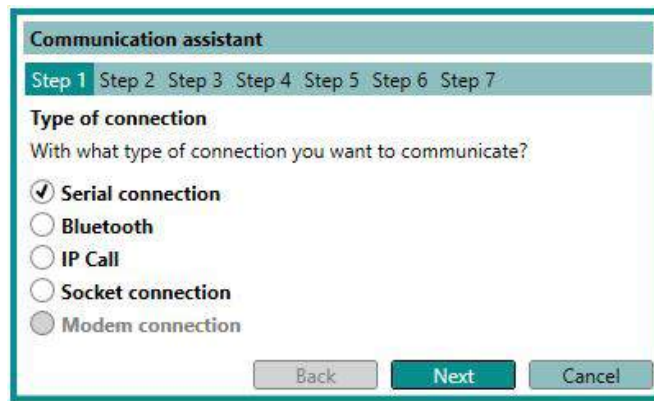

6. Make sure the MRL-7 is powered either by internal or external batteries and press [Next](#).



7. Select [Logger \(115200 Bd\)](#) and press Next.

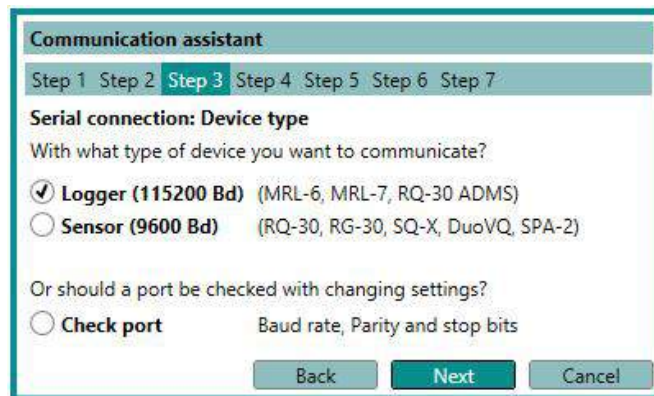

8. Either tick [Connection](#) and select a previously configured connection, or tick [Select port](#) and select the COM port that was assigned to the USB/RS-232 converter; then click [Next](#).

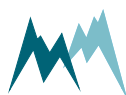

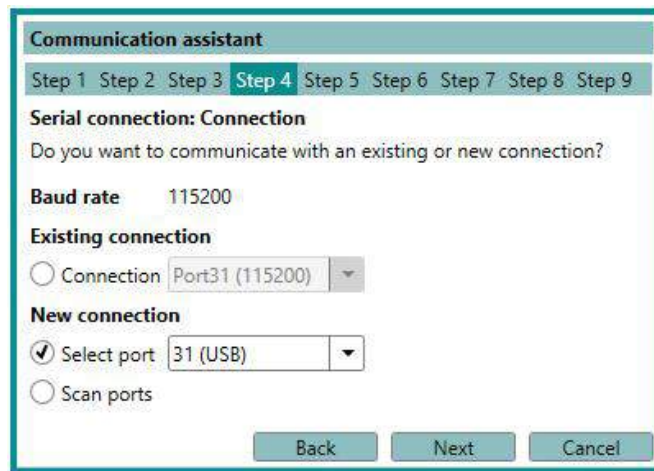

If more than one COM ports are listed and you are not sure which one to select, open the Windows Device Manager (press **Windows-key** and type *device manager*) and expand the menu **Ports (COM & LPT)**. By unplugging and re-plugging your USB/RS-232 converter you can identify the number of the desired port.

9. Select **New connection** and click **Next**.

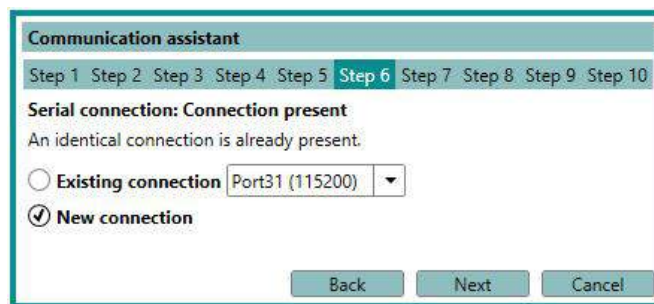

10. Assign a name to the connection and click **Next**. The software now searches for connected devices. This procedure can take several seconds.

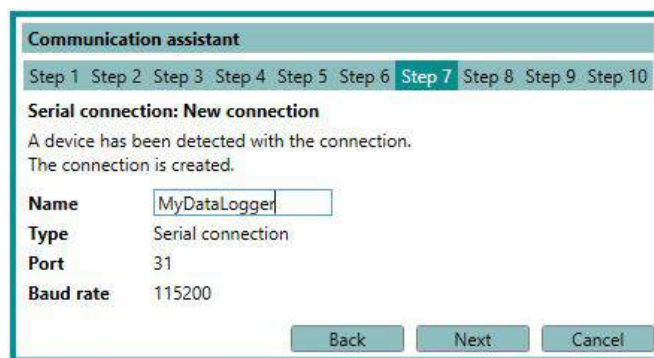

11. Select if you want to create a new station. If yes, assign an appropriate name. If a station already exists, it will be recognized and automatically selected.
12. Click **Finish**. Upon completion, the newly created connection is displayed in the

Communication section of the Commander.

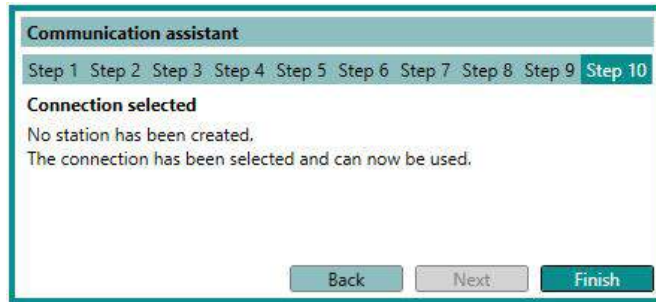

- Click **Connect** to open the connection with the data logger. If the connection was successful a green icon is displayed at the top-right corner of the Commander window.

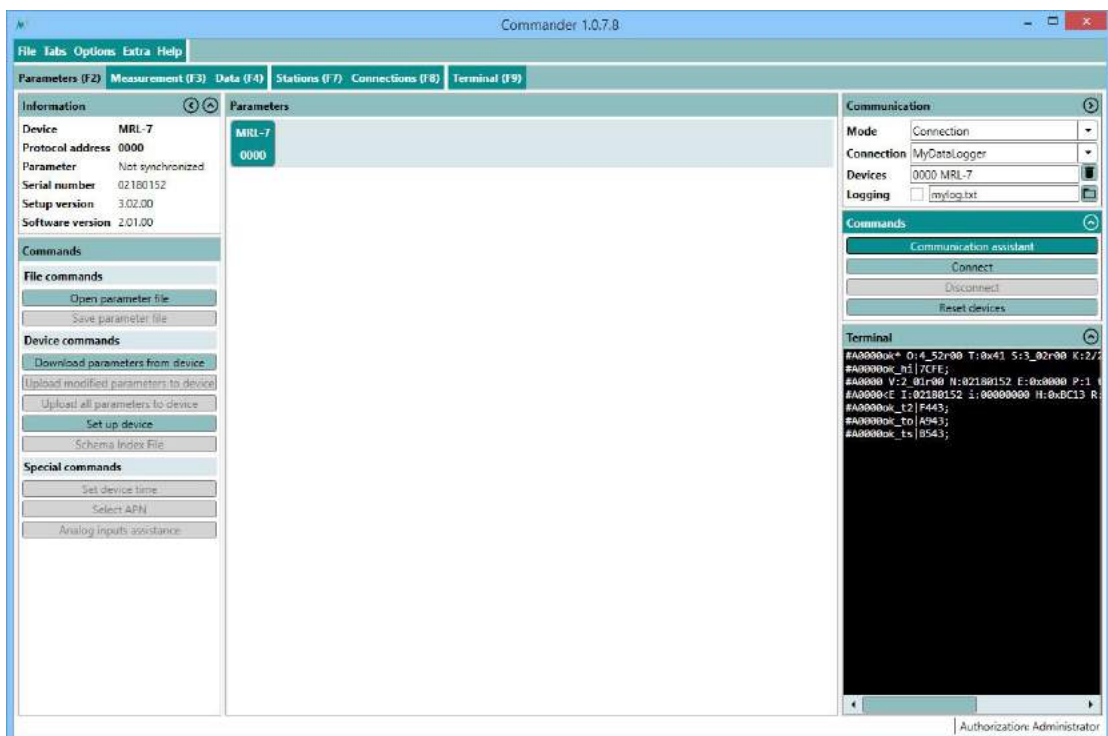

All configured connections can be viewed under the tab **Connections (F8)**.

Alternatively, a connection can be configured manually; please consult the Commander manual for detailed instructions.

9.1.2 Bluetooth

Perform the following steps to set up the communication between the MRL-7 and your PC:

- Install the Commander software on your PC.
- Make sure your PC has an internal Bluetooth or a Bluetooth dongle is connected.
- Start the Commander software.

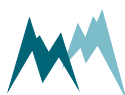

4. Make sure the MRL-7 is powered either by internal or external batteries
5. On the MRL-7 press the button **DATA BT** until the message `hold for BT` and then waiting for `BT no access` is displayed.
6. Click on Communication assistant on the right-hand side of the Commander window.

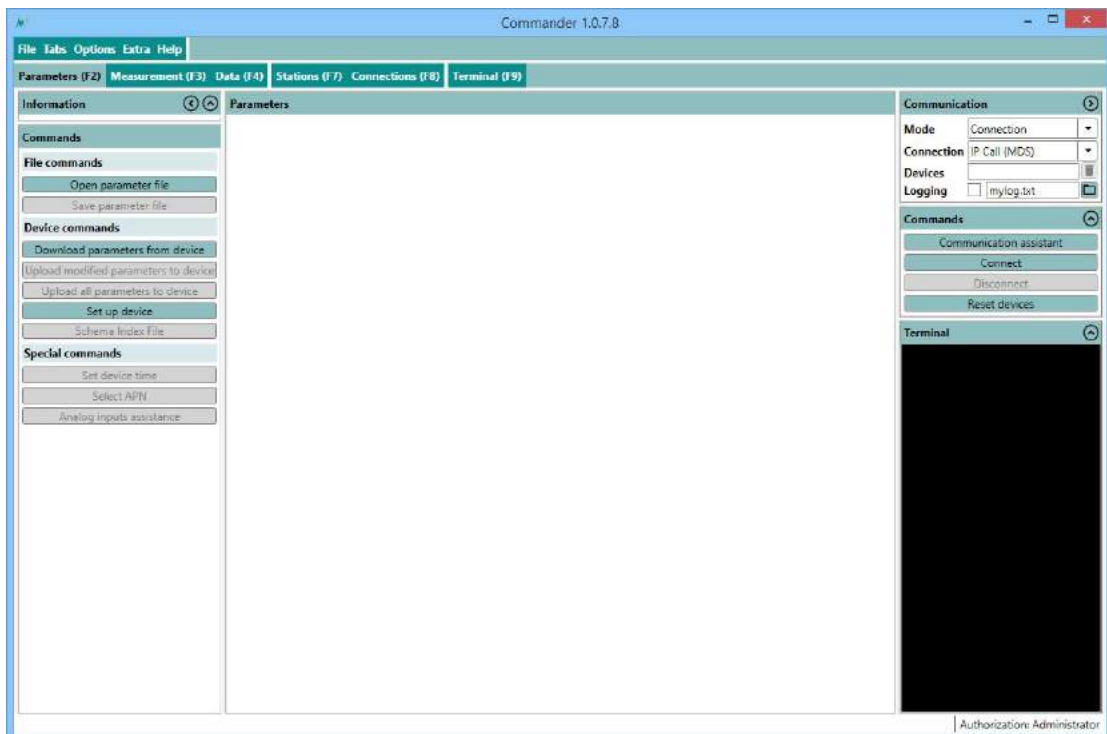

7. Select **Bluetooth** and press **Next**.

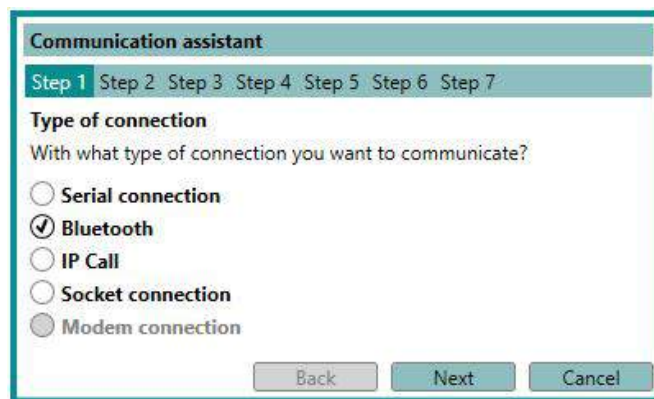

8. Select the device you want to connect to and click **Next**. The Bluetooth ID of your data logger is printed on a sticker on the MRL-7 housing. The software now searches for devices connected to your data logger. This may take a few seconds.





- Select if you want to create a new station. If yes, assign an appropriate name. If a station already exists, it will be recognized and automatically selected.
- Click **Finish**. Upon completion, the newly created connection is displayed in the **Communication** section of the Commander.

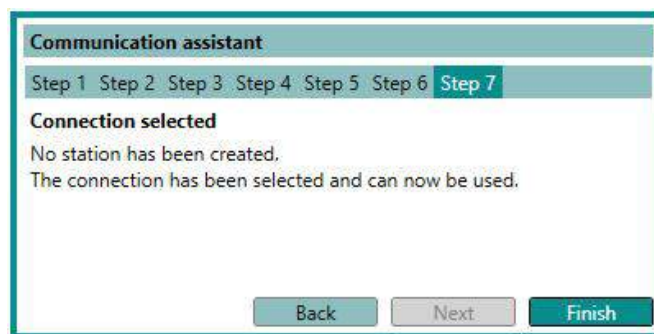

- Click **Connect** to open the connection with the data logger. If the connection was successful a green icon is displayed at the top-right corner of the Commander window.

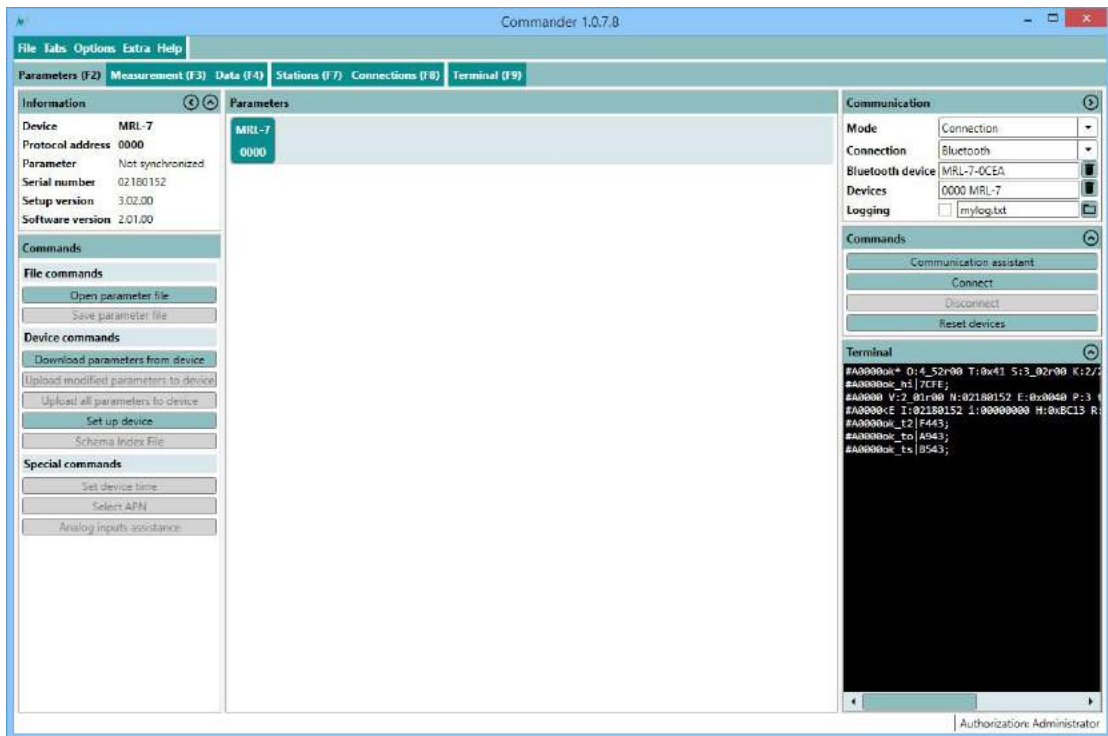

All configured connections can be viewed under the tab [Connections \(F8\)](#).

Alternatively, a connection can be configured manually; please consult the Commander manual for detailed instructions.

9.1.3 IP-Call

Perform the following steps to set up the communication between the MRL-7 and your PC:

1. Start the Commander software.
2. Click on [Communication assistant](#) on the right-hand side of the Commander window.

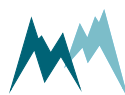

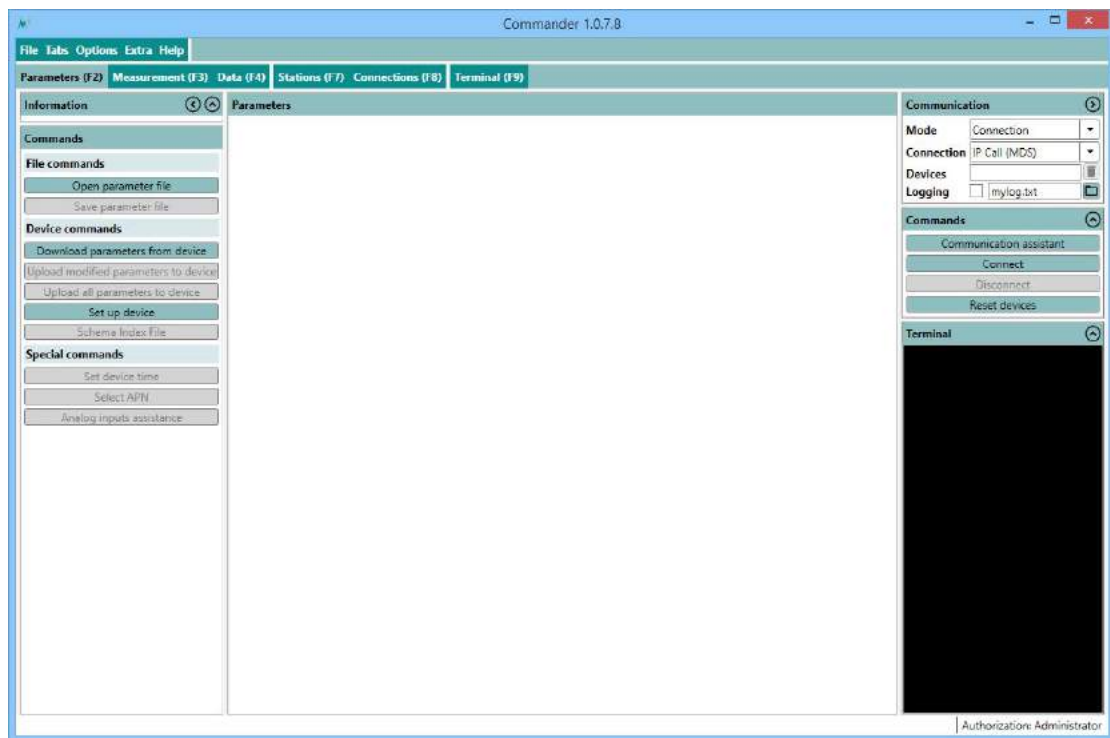

3. Select *IP Call* and press *Next*.

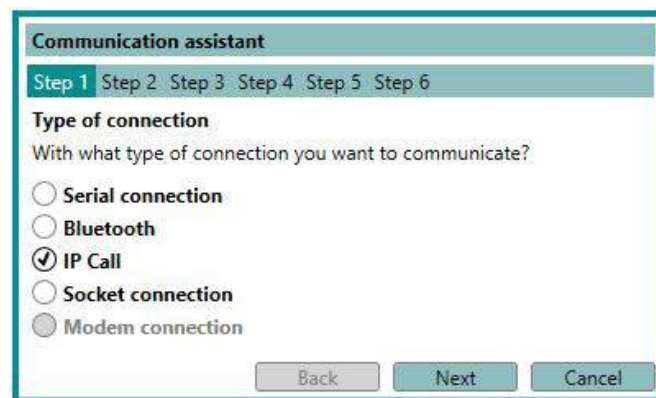

4. Select *New station* and press *Next*.



Communication assistant

Step 1 Step 2 Step 3 Step 4 Step 5 Step 6

IP Call: Station

Do you want to communicate with an existing or new station?

Existing station

Station with: "IP Call (MDS)" ARA_Hohenems

Station without: "IP Call (MDS)"

New station

New station

Back Next Cancel

5. Enter the **Station number** (usually the device's serial number), **Sommer ID**, the **Name** of the new station and your **IMSI number**. Then press **Next**.

Communication assistant

Step 1 Step 2 Step 3 Step 4 Step 5 Step 6

IP Call: New station

A new station will be created.
Enter the information and the IMSI number for the IP Call.

Station ID 31150003

Station number 31150003

Sommer ID 31150003

Name MyNewStation

IMSI number

Back Next Cancel

6. The Commander is now searching for your devices. This may take several seconds. After the communication assistant has completed the search, verify the new station settings and press **Yes**.

Communication assistant

Step 1 Step 2 Step 3 Step 4 Step 5 Step 6

New station

No matching station has been found.
Changes of the station number are performed on the device as well.

Station ID 31150003

Station number 31150003

Name MyNewStation

Devices 0000 MRL-6m

Do you want to save the station?

Back Yes No

7. Click **Finish**. Upon completion, the newly created station is displayed in the **Communication** section of the Commander.

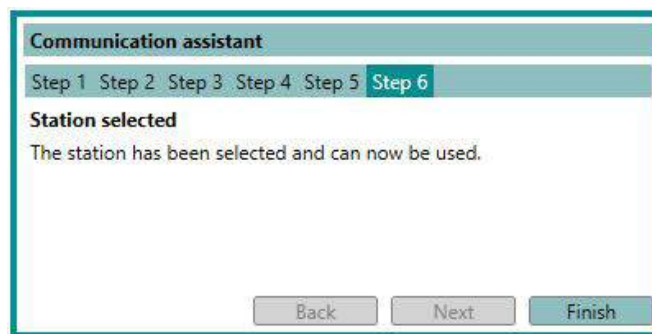

- Click **Connect** to open the connection with the data logger. If the connection was successful a green icon is displayed at the top-right corner of the Commander window.

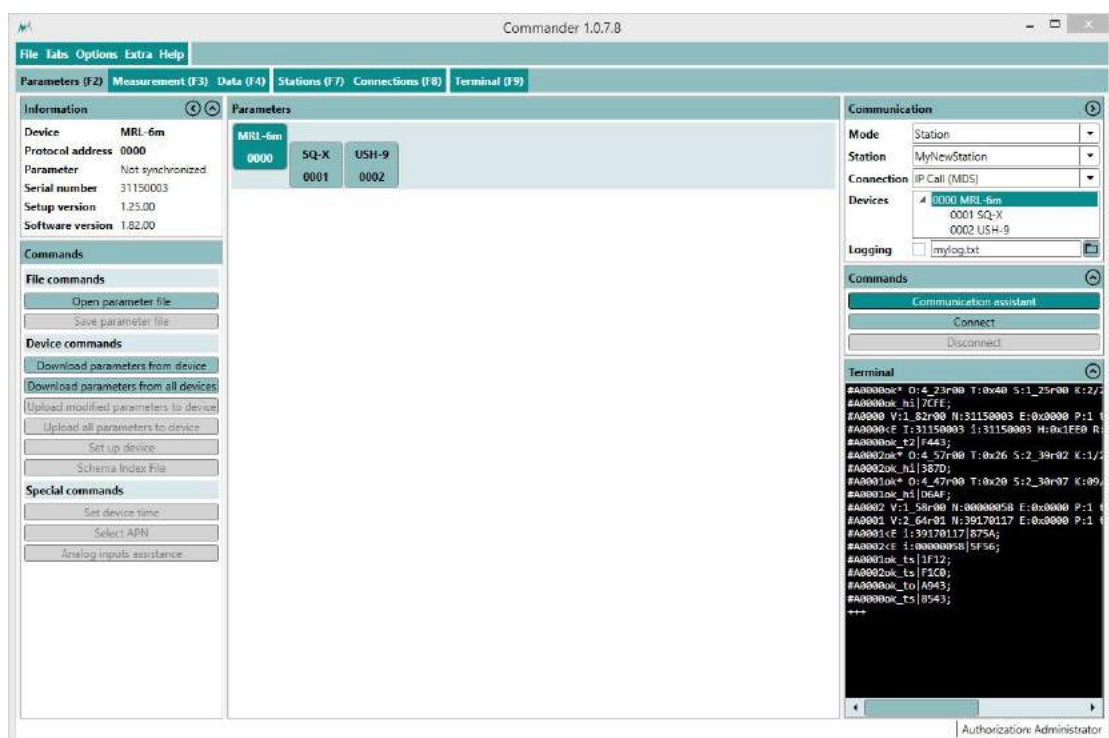

9.2 How to create a station

In order to manage several data loggers, to connect to a data logger via IP-call and to download data, stations can be created in the Commander software. To view a list of all stations select the tab **Stations (F7)**.

Perform the following steps to create a new station:

- In the tab-menu **Stations (F7)** click **New station**.
- Under **Station settings** enter the **Station number** and **Sommer ID**. By default both settings are set to the device's serial number (visible on the MRL-7 housing).

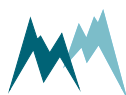

3. Select the **Connections** used for the station. Multiple selections are possible; the default connection can be selected by ticking the circular field.
4. Depending on the connection type, enter the additional information, e.g. **Address** for a Bluetooth connection or **IMSI number** for an IP call.
5. Enter the settings for **Data** management. When data are downloaded from a connected MRL-7 they are stored in an archive-file by default. Each archive-file contains the data of a year or month, as selected in **Archive type**. Selection **None** will save all data in one file. The default location for data files is C:\Users\Public\Documents\Sommer\Data\.
6. Save the newly created station with the button **Save station**.

Please consult the Commander manual for additional information on station management.

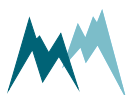

10 Support software Commander

10.1 What can I do with it?

The Commander is a multipurpose software tool to configure and operate any Sommer Messtechnik device. It offers the following functions:

- Communication with Sommer Messtechnik sensors and data loggers via serial connection, modem, socket, IP-call and Bluetooth®
- Management of connections and stations
- Configurations of sensors and data loggers
- Live data monitoring and storage
- Data management including download from data loggers and transmission to MDS (Measurement Data server)
- Terminal window to check data transfer and to access device settings directly
- Spectrum-Mode to visualize radar and ultrasonic spectra (used for diagnostic purposes, e.g., multiple reflections)

10.2 How do I install it?

10.2.1 System requirements

The Commander software supports 32- and 64-bit versions of Windows 7 SP1, Windows 8, Windows 8.1 and Windows 10.

For correct operation Microsoft® .NET Framework 4.5 or later must be installed.

10.2.2 Installation procedure

Follow the steps below to install the Commander software:

1. Plug the USB stick shipped with the device into your PC.
2. Double-click the [commander.msi](#) installer file on the USB drive.
3. Click [Next](#) on the pop-up window

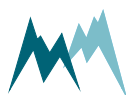



4. Read the instructions and click [Next](#)

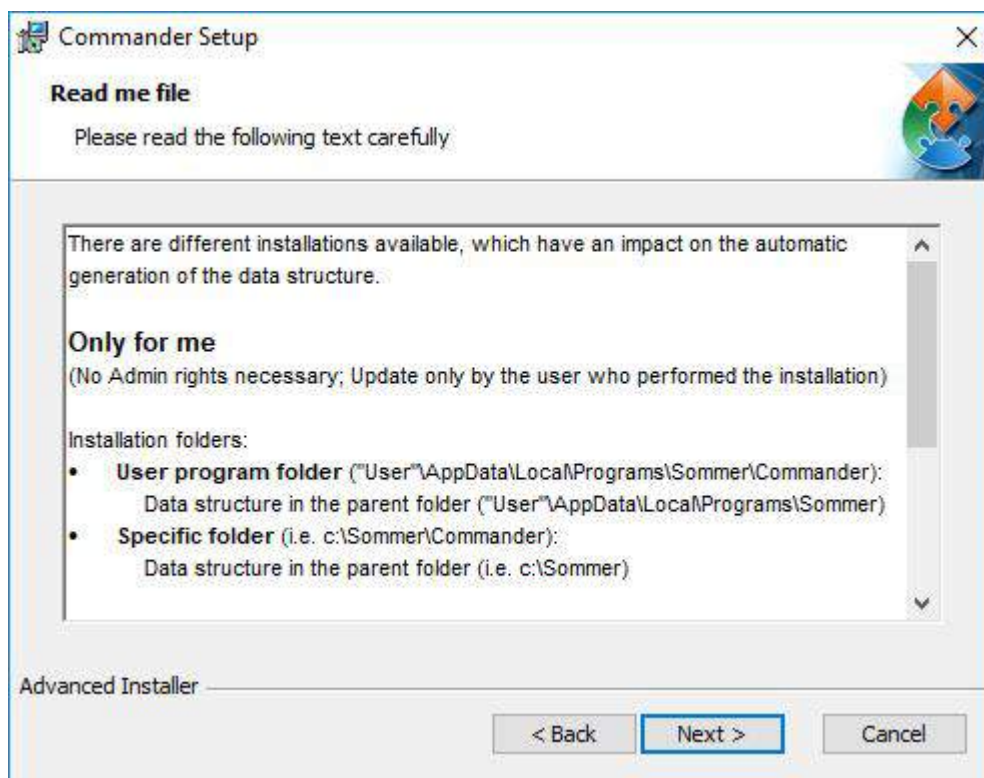

5. Select the installation type and click [Next](#)



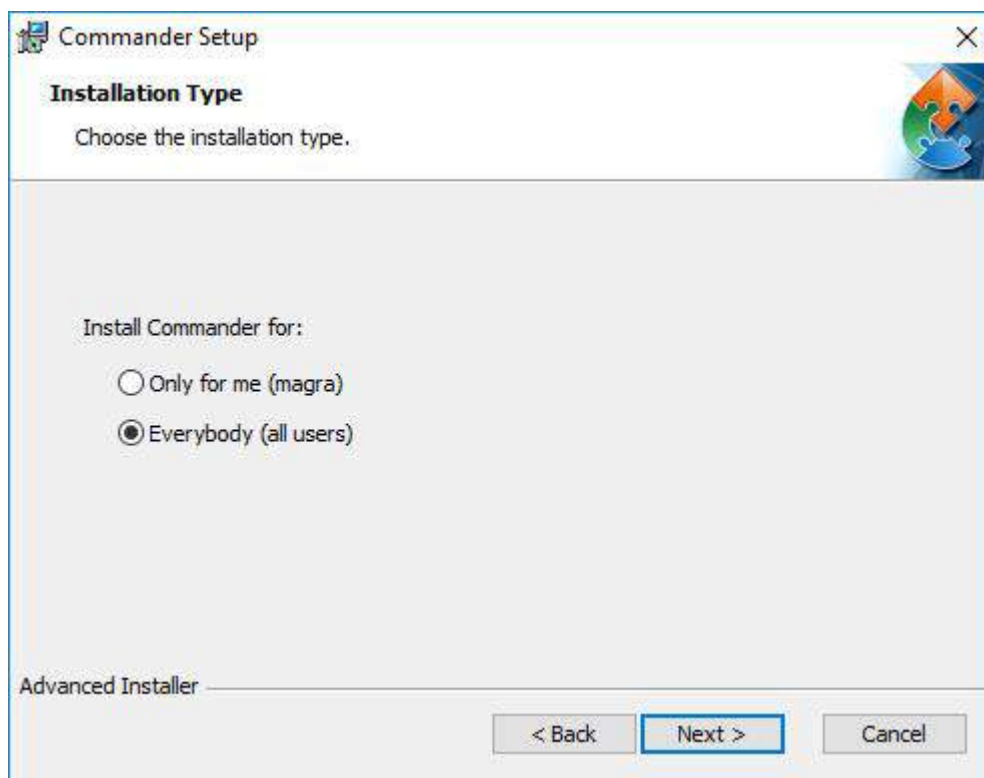

NOTE

Two installation types are available. Depending on the selection, the access rights and the folder structure differ:

Only for me

No admin rights are required. Updates are only available to the user who installed the software.

Installation folders:

- User program folder:
Users\User\AppData\Local\Programs\Sommer\Commander
Data structure:
Users\User\AppData\Local\Programs\Sommer
- Specific folder (default):
C:\Sommer\Commander
Data structure (default):
C:\Sommer

Everybody

Admin rights are required. Updates may only be performed by system administrators.

Installation folders:



- Standard program folder:
Program Files (x86)\Sommer\Commander
Data structure:
Users\Public\Public documents\Sommer
- Specific folder (default):
C:\Sommer\Commander
Data structure (default):
C:\Sommer

6. Select the installation directory and click **Next**.

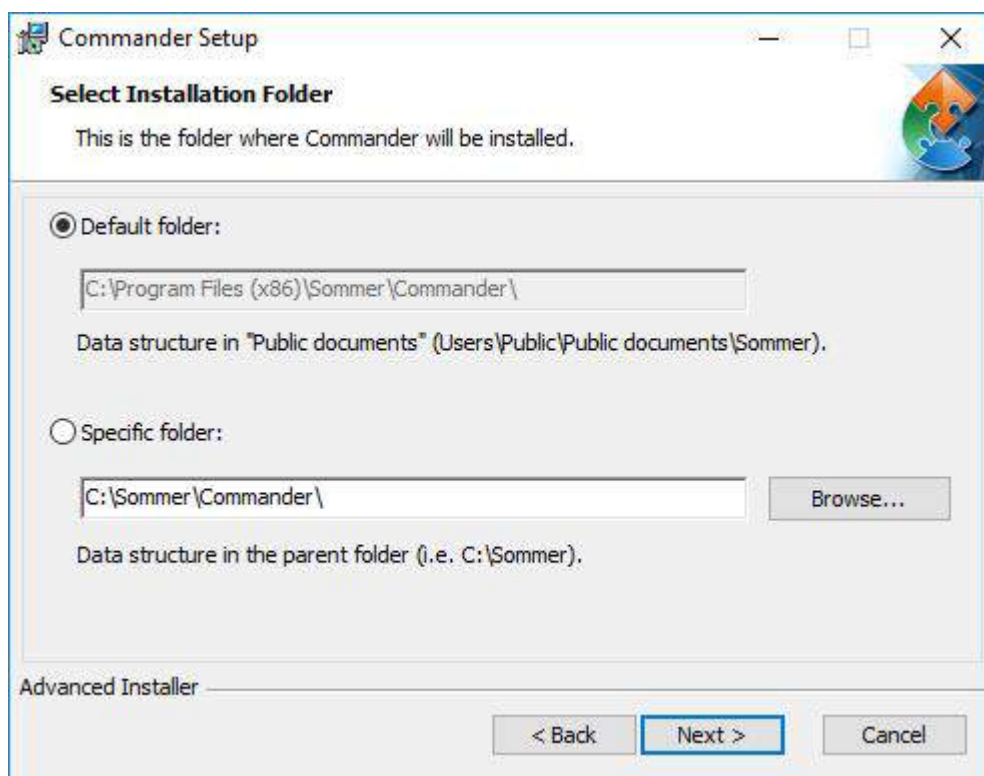

7. Select the features to be installed and click **Next**.



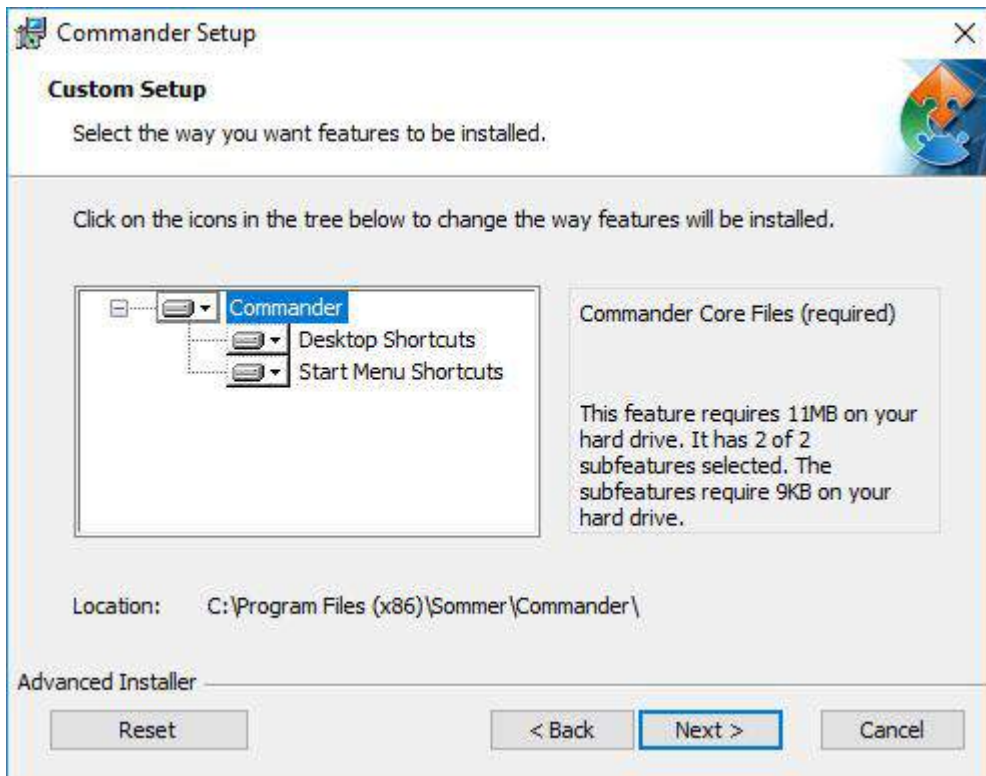

- 8. Click **Install** to start the installation.

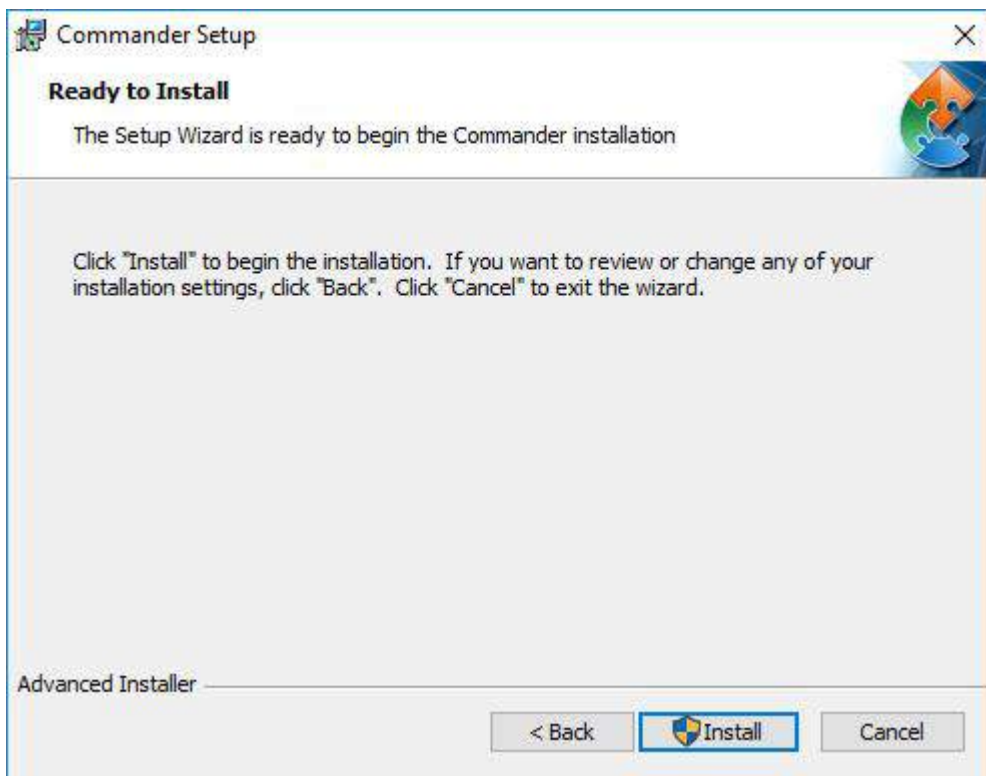

- 9. Click **Finish** to complete the installation.



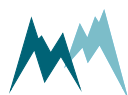

11 Configuration

The MRL-7 can be configured with one of the following tools:

- Configuration with Commander support software
- Configuration with a terminal program

11.1 Configuration with Commander support software

Follow the steps below to modify the configuration parameters of the MRL-7:

1. Establish a connection between your PC and the MRL-7 as described in [Connect the MRL-7 to a PC](#).
2. Select the tab **Parameters (F2)** and click **Download parameters from device**. The complete parameter list is transferred from the sensor to your PC and displayed in the Parameter window.

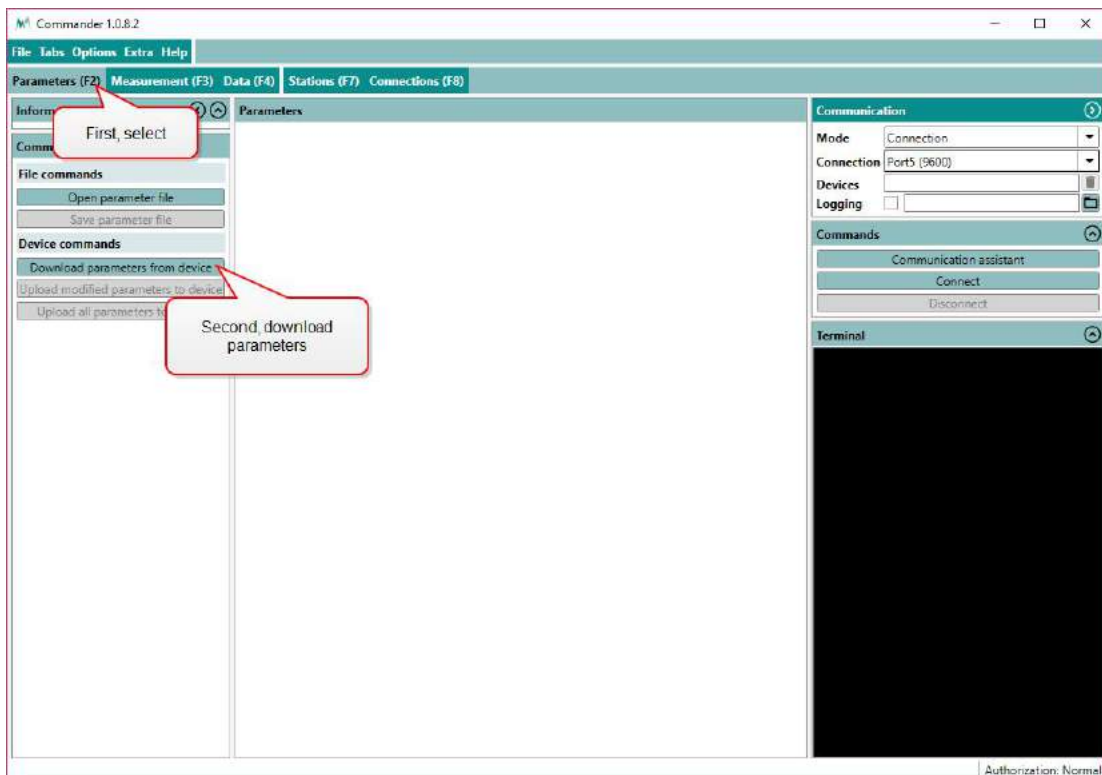

NOTE The first download of the parameter list may take a few minutes. After that the device is known to the PC and consecutive downloads are much faster.

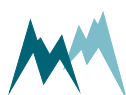

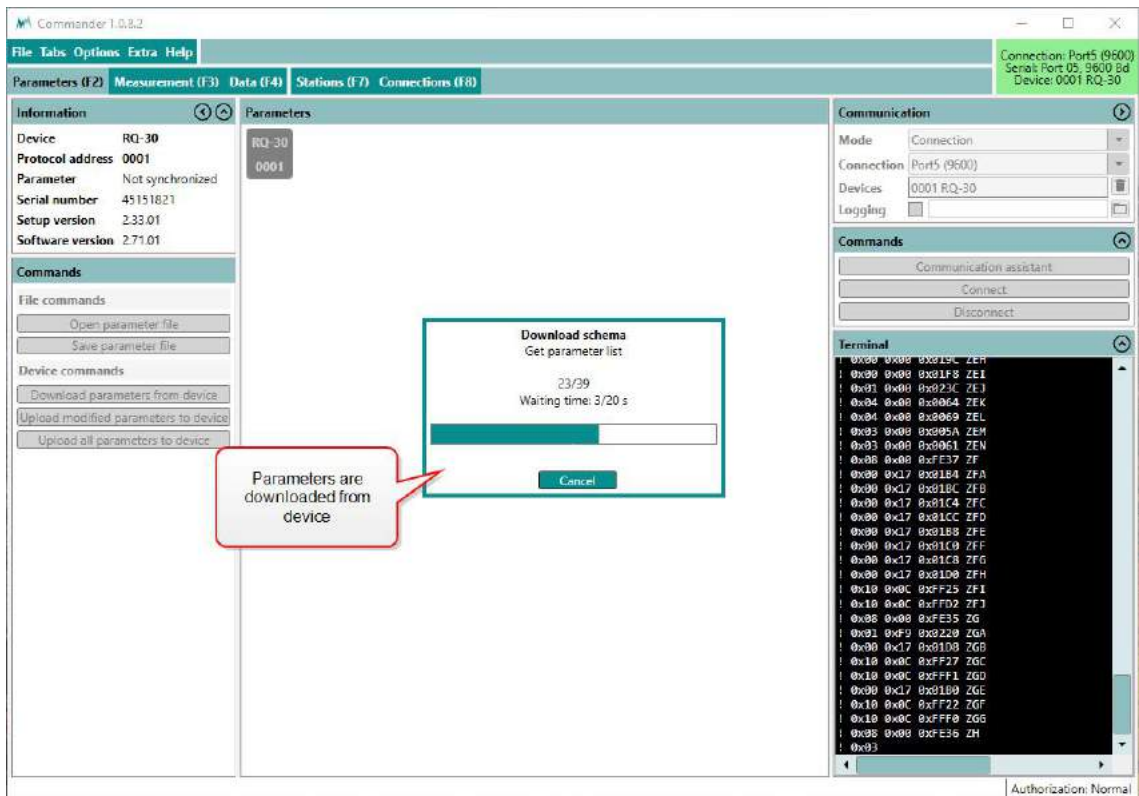

3. Save the parameter file to your PC by clicking **Save parameter file**. This step is recommended to track any configuration changes.

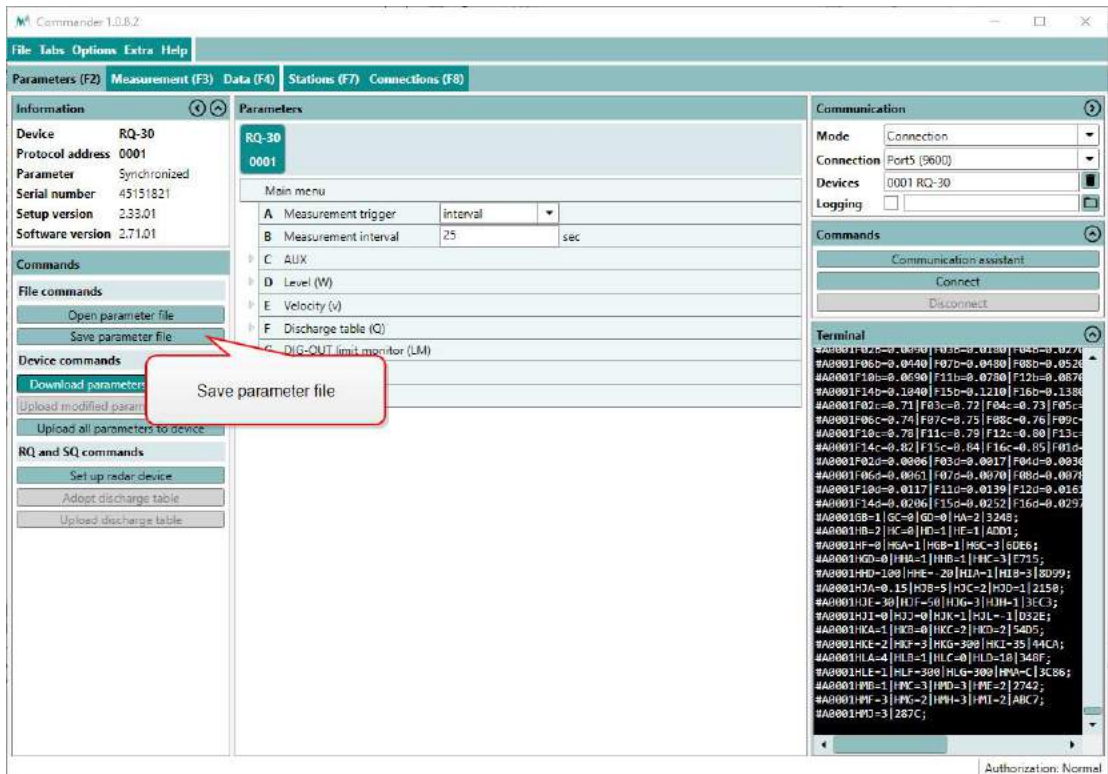

- Adapt the parameters required for your application. Changed values are displayed with a pink background.

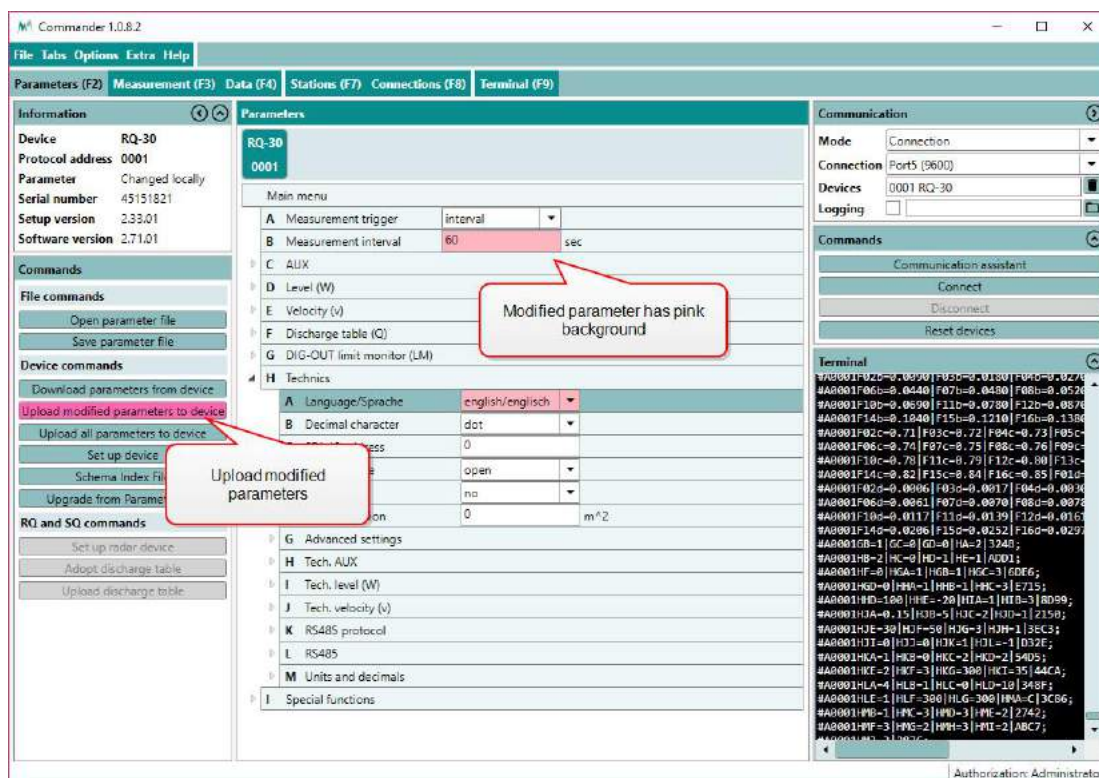

- Send the modifications to the MRL-7 by clicking **Upload modified parameters to device**. Upon successful upload the pink backgrounds disappear again.

11.2 Configuration with a terminal program

The Commander software ships with an integrated terminal program. However, communication with the MRL-7 can be performed with any terminal program.

Follow the steps below to modify the configuration parameters of the MRL-7:

- Establish a connection between your PC and the MRL-7.
- In the terminal window enter three question marks (???) in quick succession. The main parameter menu is displayed in response.

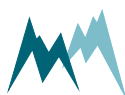

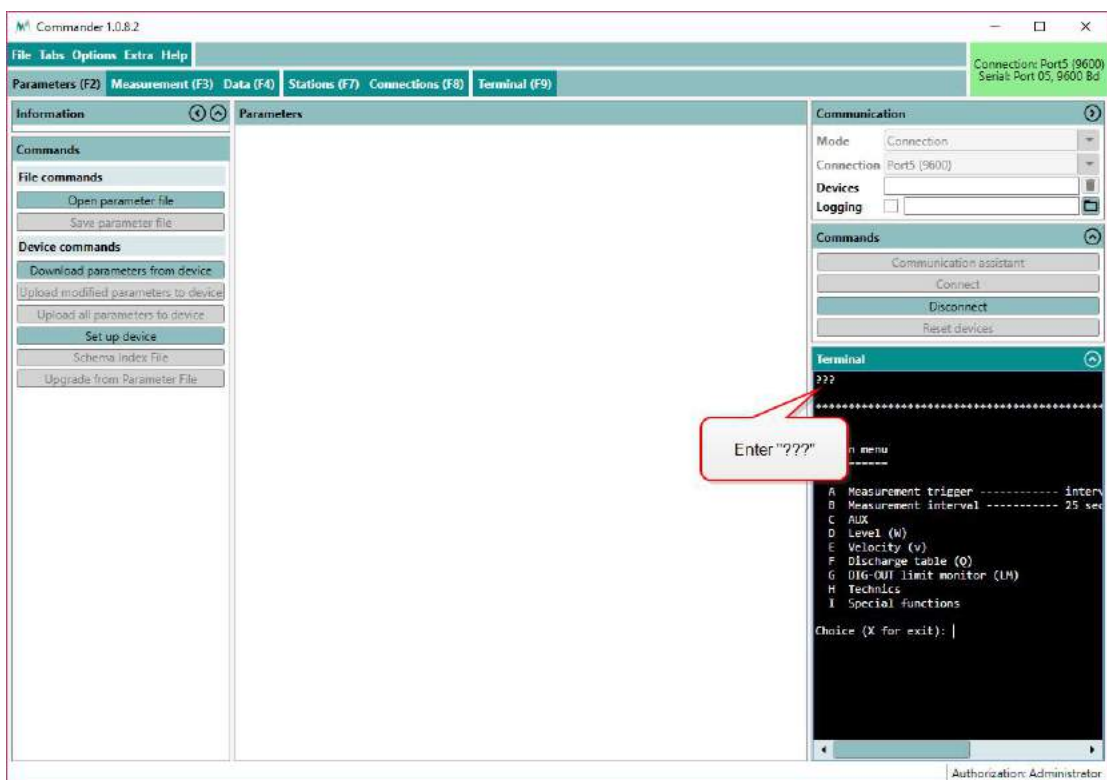

NOTE As an unwanted switching into the menu mode has to be avoided the timing of the three question marks ??? is very restrictive and must never be finished with Return/Enter. This is especially important for command line tools, which may automatically send a closing "Carriage return".

3. Read or modify the required parameters: The menu items can be selected by entering the letter assigned to each item. Upon selection a submenu is opened or the selected parameter is displayed with its unit. Changes to values are confirmed with **Return/Enter** or discarded with **Esc**. Menus are closed with **X**. After closing the main menu with **X** the sensor performs an initialization.

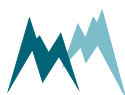

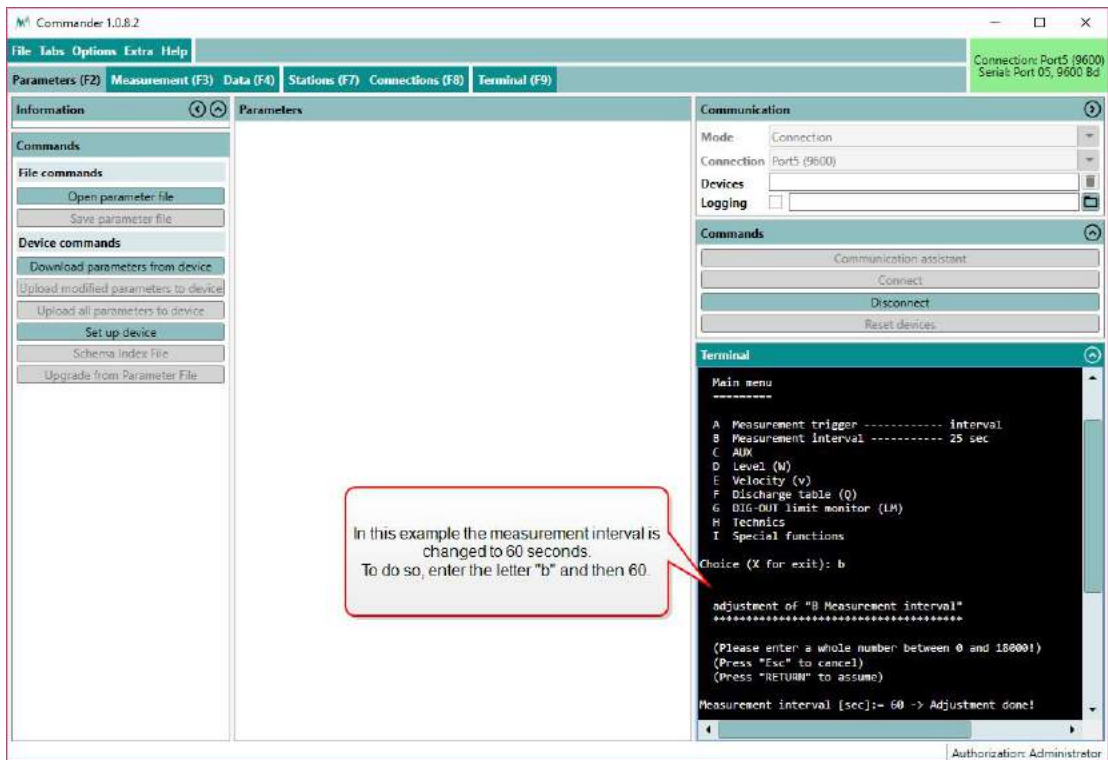

11.3 What do I need to configure?

When first setting-up a MRL-7 at a measurement site, the parameters described below may need to be adapted.

11.3.1 General settings

Station ID

By default, the station ID is set to the MRL-7 serial number. Adjust to your requirements if needed.

Station name

The name of the Station (max. 32 characters long).

Language/Sprache

The menu language.

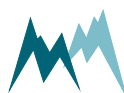

Decimal character

The character used as decimal separator in the values of the settings and in serial data strings.

Measurement Interval

The MRL-7 can perform analog, impulse counter and digital measurements at an interval between 1 s and 12 h.

Storage interval

Measurement data can be stored at a primary interval between 10 s and 12 h, specified in [Storage interval](#), or an auxiliary interval between 1 s and 24 h, specified in [Occasional storage interval](#). By default, all variables specified in the measurement table are stored in the primary interval. An exception are counter variables and some system variables which are stored in the secondary interval. By adding the command `SY` or `AS` to the field S-ADD of the measurement table, a variable can be forced to be stored in the primary or secondary interval.

In the Function field of the measurement table you can specify whether the last measurement value or an aggregated value, e.g. mean, shall be stored.

11.3.2 Measurement table

The data acquired by the MRL-7 are configured in the measurement table. The screenshot below shows an example of a measurement table for an automatic weather station equipped with a combined temperature/humidity sensor, wind speed/direction sensor and a tipping bucket rain gauge.

	Function	Identifier	Unit	Decimals	Scale	Offset			S-TYP	S-NUM	S-MEA	S-ADD
01	actual	Air Temperature	°C	2	100	-40	Adjustment	Test	AIN		An1	
02	actual	Rel. Humidity	-	1	100	0	Adjustment	Test	AIN		An2	
03	meanval	Wind Speed	m/s	2	0.098	0	Adjustment	Test	WIND		speed	
04	maximum	Wind Speed	m/s	2	0.098	0	Adjustment	Test	WIND		speed	
05	meanval	Wind Direction	°	1	1.0	0	Adjustment	Test	WIND		direct.	
06	intens.	Precipitation	mm/h	1	6.0	0	Adjustment	Test	COUNT		Counter 1	
07	sum	Precip. Daily	mm	1	0.1	0	Adjustment	Test	COUNT		Counter 1	SY
08	actual	Battery Voltage	V	1	1.0	0	Adjustment	Test	SYS	0	+Bat V	
09	intens.	count		as S		0,0	Adjustment	Test	COUNT		Counter 1	

The MRL-7 distinguishes between measurement variables and auxiliary measurement variables. The latter are generally used for live monitoring and are not stored on the data logger. For example, the current wind speed could be configured as an auxiliary variable, and the 10-minute average as a regular variable that is stored on the data logger. The number of both variable types can be set in [Measurements, max. number](#) and [Aux measurements, max. number](#) and is limited to 99 in total.

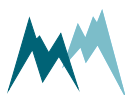

Please refer to [Measurement table](#) for a detailed description of the fields and their options. The configuration of different sensor types is described in Section [Data acquisition examples](#).

11.3.3 Messages & Actions

In the measurement table described above, limit values can be specified for critical variables. If a limit value is violated the MRL-7 can perform one of the following actions specified in [Messages, table](#):

Message	Description
off	No message is sent.
Switch	A switch output is closed if a trigger condition is satisfied.
E-Mail	An E-mail is sent to a defined recipient if the trigger condition is satisfied. Not available with MRL-7 O-Versions.
text	A SMS message is sent to a defined recipient if the trigger condition is satisfied. Not available with MRL-7 O-Versions.

The following screen shot shows an example of the different actions:

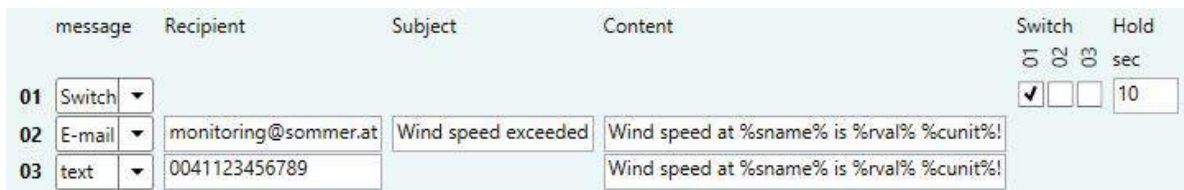

As shown in this example, the messages can contain special commands to provide precise information about the trigger condition. Here, `Wind speed at %sname% is %rval% %cunit%!` is received as `Wind speed at AWOS_01 is 31.24 m/s!` . See [Messages, table](#) for a full list of available codes.

The actions can be linked to the measurement table by ticking the corresponding Messages fields. Up to 16 actions can be specified and associated with multiple variables.

11.3.4 Totalizer reset options

Precipitation and discharge measurements, among others, require a totalizer function. For example, in water management it is common to report water discharge as monthly totals.

To configure a totalized variable with a daily reset, the [Function](#) field in the measurement table has to be set to `sum` and the [Sum, reset time](#) has to be set to the required time.

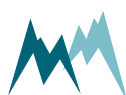

11.3.5 Telecommunication modem

For remote communication with the data logger and data transfer the following settings of the MRL-7 modem need to be configured:

Modem functionality

Switches the modem functionality on or off.

SIM pin

Either the PIN code of your SIM card or -1 if no PIN is required.

APN address, APN username, APN password

The access point name, username and password of your mobile network provider. Please note, that some provides do not require a username and password.

In case you do not have the APN information at hand, the Commander software contains a list of most providers (see [Figure 10](#)). In the [Special commands](#) section of the [Parameter \(F2\)](#) window click [Select APN](#) and choose your provider. After clicking [OK](#) the APN information will be adopted in the parameter list. Click [Upload modified parameters to device](#) to write the changes to the MRL-7.

MCC	Country	Provider	APN	User	Password
231	Slovakia	Orange World	orangewap	wap	wap
231	Slovakia	T-Mobile internet	internet		
231	Slovakia	O2 internet	o2internet		
232	Austria	live!	a1.net	ppp@a1plus.at	ppp
232	Austria	T-Mobile LTE	internet.t-mobile.at	t-mobile	tm
232	Austria	Planet 3	drei.at		
232	Austria	tele.ring web	web	web@telering.at	web
232	Austria	Planet3	drei.at		
232	Austria	data.bob	bob.at	data@bob.at	ppp
232	Austria	yesss!	web.yesss.at		
234	United Kingd	UBIQUISYS	internet		
234	United Kingd	O2 MOBILE WEB	mobile.o2.co.uk	O2web	O2web
234	United Kingd	BT One Phone Internet	internet.btonephone.cc		

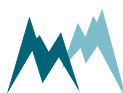

Figure 10 APN selection list

11.3.6 E-Mail settings

If the e-mail-message option described in [Messages & Actions](#) is used, a valid e-mail account needs to be specified in [E-mail/SMTP](#):

E-mail/SMTP

The name of the SMTP server used to send e-mails, e.g. *smtp@emailprovider.com*.

Sender

The e-mail address of the sender, e.g. *sender.name@emailprovider.com*.

Username

The username for the used e-mail account. Usually identical to [Sender](#).

Password

The password for the used e-mail account.

Port

The port of the used SMTP server, usually [25](#), or [587](#) if SSL is used.

 **NOTE** SOMMER Messtechnik does not provide e-mail services! Please contact your IT department to setup an e-mail account, or create your own account with an online-provider, e.g. Google, Yahoo,...

 **TIP**
To test E-mail transmission, define a random variable in [Measurement table](#) with [Scale 0](#) and [Offset 10](#), and set a limit value as in the following example.

Function	Identifier	Unit	Decimals	Scale	Offset	S-TYP	S-NUM	S-MEA	S-ADD	Limit	Messages		
01	actual	Test	-	1	0	10	Adjustment	Test	SYS	0	+Bat V	50	<input checked="" type="checkbox"/>

To trigger a message, increase [Offset](#) to a value above [Limit](#) and upload the parameter to the MRL-7.

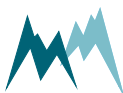

11.3.7 Remote access

The Commander software communicates with a remote MRL-7 via IP-Call. To enable communication the following settings need to be adjusted:

IP Call server and IP Call port

The address and the port of the server used for IP-calls.

IP Call interval

The interval at which the MRL-7 listens to IP call requests. The default interval of one minute is generally adequate.

Stand-by time

To reduce power consumption and to restrict access to the data logger, a time window for IP-calls can be specified with [Standby, start time](#) and [Standby, duration](#).

11.3.8 Device clock

The clock of the MRL-7 is powered by an internal lithium button cell battery that needs regular synchronization. After connection with the Commander software, the time can be set by clicking [Set device time](#) in the [Parameters \(F2\)](#) tab.

For autonomous operation, the time is generally synchronized by an NTP server, which is configured by the following settings:

NTP server and NTP port

The address and the port of the time server.

Synchronization time

The time at which the clock of the MRL-7 is synchronized every day. This time should not overlap with any other communication task of the data logger.

Time zone

The offset between the time zone in which the MRL-7 is operating and UTC in seconds.

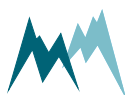



NOTE Time synchronization by an NTP server ignores daylight saving time! If automatic time synchronization is active, it removes a manually entered daylight saving time at the next synchronization.

11.3.9 Camera

A digital camera with RS-485 communication can be used with the MRL-7. If connected, it records pictures in the specified [Data transmission interval](#) and stores them on the MicroSD card if present. For automatic operation the following settings have to be configured:

Switch

The number of the switched 12-V supply (SW) which powers the camera.

Warm-up time

The time required by the camera to get ready for recording.

Solar nightshutdown

This switch offers the option to shut down the camera during the night. Requires a connected solar panel.

11.3.10 Data transmission

To enable scheduled data transmission, an HTTP or FTP server has to be specified in at least one of the three available server configurations ([Data transmission 1](#), [Data transmission 2](#) or [Data transmission 3](#)). By default, the *Measurement Data Server* (MDS) of SOMMER Messtechnik is configured. If you have subscribed to this service, you can access the transmitted data on the server's webpage. To complete the data transmission setup you may need to adapt the following settings:

Target server type

The server type to which the data are sent to; either FTP or HTTP.

Data transmission interval

The interval at which data are transmitted from the data logger to the server. The interval is entered in the format hh:mm:ss. For example, to transmit data each hour 01:00:00 has to be

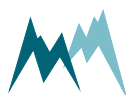

entered.

At each interval, data since the last successful transmission are sent to the server. A copy of the data remains on the data logger until overwritten by newer data.

Data transmission offset

If multiple communication tasks are configured, the offset is used to separate these tasks and thus avoid transmission conflicts. The offset is entered in the format hh:mm:ss. For example, an offset of one minute has to be entered as 00:01:00. Each data transmission configuration should have a different offset.

Content

Specifies whether measurement data or camera images need to be transmitted to the server. If both is required, two separate data transmission tasks need to be configured.

FTP port or HTTP port

The port at which the data server is listening for data transmissions. Generally, for FTP the port is [21](#) and for HTTP [80](#).

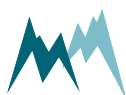

12 Serial communication

The MRL-7 is equipped with one RS-232 and one RS-485 interface. While the first is designated for communication of the data logger with a PC, the latter can be configured to communicate with digital sensors, a camera and other data acquisition devices.

12.1 Which data do I get?

The MRL-7 includes a RS-485 and a SDI-12 interface for communication and data output. The measurement values returned by one of these ports are arranged in a fixed sequence and are identified by the index in [Measurement table](#). See section [Data acquisition examples](#) for measurement table examples.

12.1.1 Exception values

Measurement data may be returned with the following exception values:

Value	Description
9999.998	Initial value: No measurement has been performed yet (position of decimal character is irrelevant).
9999.997	Conversion error: Caused by a technical problem (position of decimal character is irrelevant)
9999999	Positive overflow
-9999999	Negative overflow

Table 8: Exception values

12.2 RS-232

12.2.1 How do I configure it?

The settings of the RS-232 port are listed in [Com-1 port](#) . The format and timing of the data output via RS-232 can be configured in [Com-1 protocol](#) .

By default the serial port of the MRL-7 is configured as follows:

Baud rate	115200
Data bits	8
Parity	none

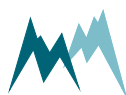

Stop bits	1
Flow control	none

System key and device number

The system key and device number are used to identify a MRL-7 in a bus system. This is essential if multiple devices (MRL-7 and data loggers) are operated within the same system.

System key

The system key separates different conceptual bus systems. This may be necessary if the remote radio coverage of two measurement systems overlap. In general, the system key should be set to *00*.

Device number

The device number is a unique number that identifies a device in a bus system.

OP, measurement output

The serial data output can be triggered in the following ways:

Option	Description
just per command	The output is only requested by commands via the RS-485 or SDI-12 interface.
measured values push	Data are returned automatically after each measurement.
storage values push	Data are returned automatically after they have been written to the data logger memory.

12.3 RS-485

12.3.1 What is it?

RS-485 is a serial communication method for computers and devices. It is currently a widely used communication interface in data acquisition and control applications where multiple nodes communicate with each other.¹

¹<https://www.lammertbies.nl/comm/info/RS-485.html>

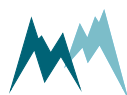

12.3.2 What can I do with it?

RS-485 communication is primarily used to trigger measurements and read their results. It also permits to change parameters of the MRL-7.

12.3.3 How do I wire it?

Application examples that use RS-485 communication are described in [Measurements & data acquisition](#).

12.3.4 How do I configure it?

The MRL-7 has serial RS-485 communication enabled by default. If the device is integrated into a RS-485 network or connected to a stand-alone data acquisition system, e.g. a data logger, the parameters listed in [RS-485-1 Protocol](#) may need to be adapted:

RS-485-1 Port

By default the serial port of the MRL-7 is configured as follows:

Baud rate	9600
Data bits	8
Parity	none
Stop bits	1
Flow control	none

Operation modes

The MRL-7 supports different modes to acquire data from various digital sensors.

This is the default operation mode: The measurements are triggered internally by the sensor and the data are transferred automatically to the MRL-7. To enable this mode, turn off [Trig, polling](#) and configure your digital sensor to trigger measurements by itself.

The MRL-7 triggers the measurements of the connected sensor. The sensor returns the data automatically after each measurement. To run the data logger in this mode, turn on [Trig, polling](#) and configure your digital sensor to return data after each measurement.

Some digital sensors perform measurements in an internally programmed interval and send out data only upon request from a data acquisition device. To enable the MRL-7 to send a data request to this type of sensor, the command `TD` (poll data without triggering a measurement) has to be added to the first requested variable of the sensor in [Measurement table](#)

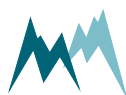

Output protocols

For data output via RS-485 different protocols are available, which can be selected under [Output protocol \(OP\)](#).

12.3.5 How is the output structured?

Data are returned in two different formats, selectable in [Output protocol \(OP\)](#):

- [Sommer protocol](#)
- [Standard protocol](#)

12.3.6 Sommer protocol

The data string of the Sommer protocol has the following format:

 **EXAMPLE** #M0001G01se01 1461|02 1539|03
25.25|04 0|3883;

Header

The header (#M0001G00se) identifies the data by system key, device number and string number.

Parameter	Format	Description
Start character	#	
Identifier	M	M identifies an output string
System key	dd	
Device number	dd	
Command ID	G	G defines an output string with string number
String number	dd	01 Output values
Command	se	se identifies automatically sent values

Table 9: Header of the Sommer protocol

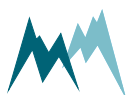

Measurement value

A measurement value (02 1539 |) has a length of 8 digits and is returned together with its index. If the measurement value is a decimal number, one digit is reserved for the decimal character. Values are returned right-aligned, so blanks may occur between index and value.

Parameter	Format	Description
Index	dd	2 numbers
Value	xxxxxxxx	8 character right-aligned
Separator		

Table 10: Values in Sommer protocol

End sequence

The data string is terminated with a CRC-16 in hex format (3883) followed by an end character and <CR><LF>. The CRC-16 is described in [Sommer CRC-16](#).

Parameter	Format	Description
CRC-16	Hhhh	4-digit hex number
End character	;	
Control characters	<CR><LF>	Carriage return and Line feed

Table 11: End sequence of the Sommer protocol

Example Sommer protocol

Output values

The acquired data are returned as in the following example:

Parameter	Format	Description
EXAMPLE	#M0000G00se01	17.25 02
	65.13 03	2.41 04
	7.08 05	145.2 06
	0.3 07	0.6 08
	12.0 1978;	

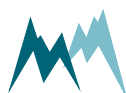

#M0000G00se	Header with system key 00, device number 00 and string number 00
01 17.25	Air Temperature
02 65.13	Rel. Humidity
03 2.41	Wind Speed (instantaneous)
04 7.08	Wind Speed (maximum)
05 145.2	Wind Direction (average)
06 0.3	Precipitation
07 0.6	Precip. Daily
08 12.0	Battery Voltage
1978;	Closing sequence

Table 12: Main values returned by the Sommer protocol

12.3.7 Standard protocol

The data string of the Standard protocol has the following format:

	EXAMPLE M_0001 1461 1359 25.38 0
---	---

Header

The header (M_0001) identifies the data by system key and device number.

Parameter	Format	Description
Identifier	X_	M_ Measurement values
System key	Dd	
Device number	Dd	

Table 13: Header of the Standard protocol

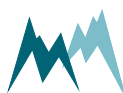

Measurement values

Measurement values are returned in sequence and are separated by a blank. A measurement value has a length of 8 digits. If the measurement value is a decimal number, one digit is reserved for the decimal character. Values are returned right-aligned, so additional blanks may be returned between values.

Parameter	Format	Description
Separator	[blank]	blank
Value	xxxxxxxx	8 character right-aligned

Table 14: Values in Standard protocol

End sequence

The data string is terminated with <CR><LF>.

Example Standard protocol

Output values

The acquired data are returned as in the following example:

EXAMPLE
M00_0000 17.25 65.13 2.41 7.08
145.2 0.3 0.6 12.0

M00_0000	Header with identifier for measurement values
17.25	Air Temperature
65.13	Rel. Humidity
2.41	Wind Speed (instantaneous)
7.08	Wind Speed (maximum)

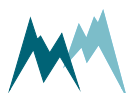

145.2	Wind Direction (average)
0.3	Precipitation
0.6	Precip. Daily
12.0	Battery Voltage

Table 15: Main values returned by the Standard protocol

12.3.8 Which commands are available?

Command structure

The structure of serial commands and answers (`#W0001$mt|BE85;`) is described in the following table:

Parameter	Format	Description
Start character	#	
Identifier	X	<p>W MRL-7 returns a confirmation on receipt. This command type demands a closing sequence with a valid CRC-16.</p> <p>S MRL-7 does not acknowledge the receipt of the command. This command type demands no closing sequence and therefore no CRC-16.</p> <p>R MRL-7 returns the requested measurement value or parameter. This command type demands a closing sequence with a valid CRC-16.</p> <p>T Write a volatile setting and receive a confirmation</p> <p>A Answer of device to read or write command</p>
System key	dd	
Device number	dd	

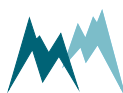

Parameter	Format	Description
Command	xxx	See Commands
Separator		
CRC-16	hhhh	4-digit hex number
End character	;	

Table 16: Structure of RS-485 commands and answers

Commands

The following commands can be used with the MRL-7:

Command	Description
\$mt	Trigger a measurement
\$pt	Return measurement values
XX	Read a parameter with identifier XX
XX=xxxxx	Write a parameter with identifier XX and the value xxx

Table 17: List of RS-485 commands

Trigger a measurement

The command \$mt triggers a complete measurement sequence as in the following example:

	EXAMPLE #W0001\$mt BE85;	Answer: #A0001ok\$mt 4FA9;
---	---------------------------------	-----------------------------------

Read a parameter value

Read measurement interval (in the example below the menu item B):

	EXAMPLE #R0001B 228E;	Answer: #A0001B=300 F8B3;
---	------------------------------	----------------------------------

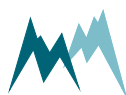

Request a complete data string

The command `$pt` requests a data string as in the following example:



EXAMPLE `#S0001$pt|`

Answer: none

The data string is returned as soon as the MRL-7 has processed the command.

Request a single measurement value

The reading command `R` together with the index of the requested measurement returns a single measurement value. In the following example the measurement value with index 01 (in this example a water level) is requested:



EXAMPLE

`#R0001_010cv|EA62;`

Answer: `#A0001ok_010cv1461 |07EB;`

12.3.9 Sommer CRC-16

The CRC-16 (cyclic redundancy check) used in data transmission of Sommer devices is based on the ZMODEM protocol. When data are exchanged between two devices the receiving device calculates the CRC-value. This value is compared to the CRC value sent by the other device to check if the data were transmitted correctly. Please refer to technical literature or contact Sommer for calculation of CRC-16 values.

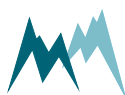

13 Data acquisition examples

As listed in [What can I do with it?](#) the MRL-7 accepts a wide range of sensor inputs. In this section the data acquisition of the most common sensor types is described.

13.1 Power considerations

The MRL-7 provides analog sensor supply of 100 mA at 12 V. Additional, switched, potential free supplies provide max. 2 A (at 12 V).

 **NOTE** Many digital sensors require a supply current >100 mA. If such sensors are connected to the MRL-7, they need to be powered by an external power supply with a sufficient source current.

13.2 Analog measurements

With the MRL-7 single ended and differential voltage signals in the range of 0 to 2.5 V can be measured. The analog inputs [AN3](#) and [AN4](#) can also be configured to measure resistive sensors, e.g. PT1000, and sensors with a current output.

The signals received from a sensor are wired in the MRL-7 as illustrated in [Figure 11](#).

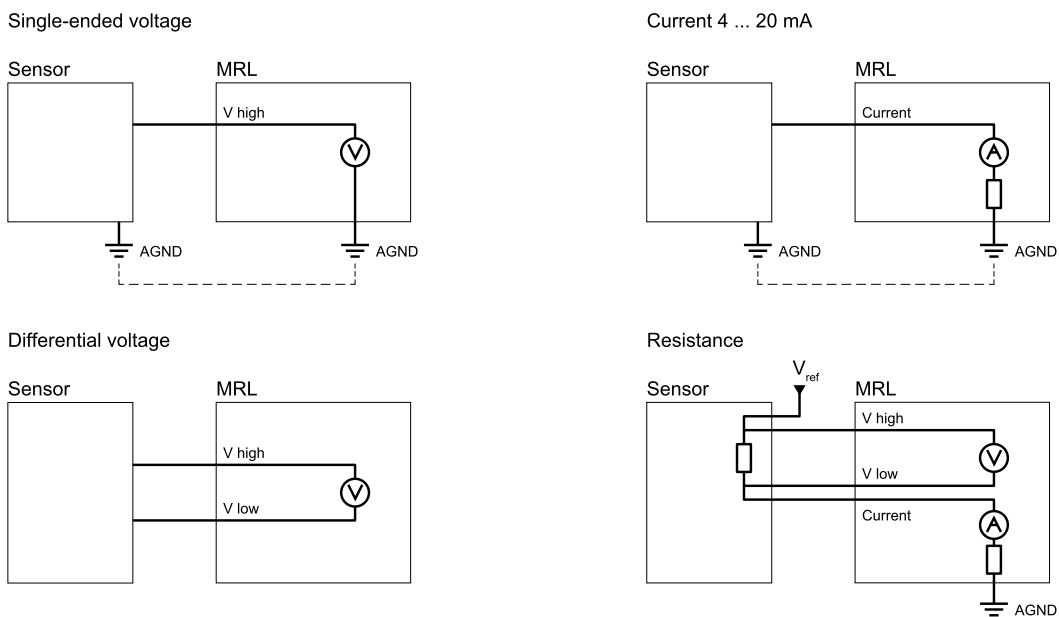
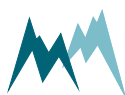

Figure 11 Internal wiring of analog MRL-7 inputs



13.2.1 Principals

The illustration below shows two measurement intervals of three analog inputs (AN1, AN2 and AN3).

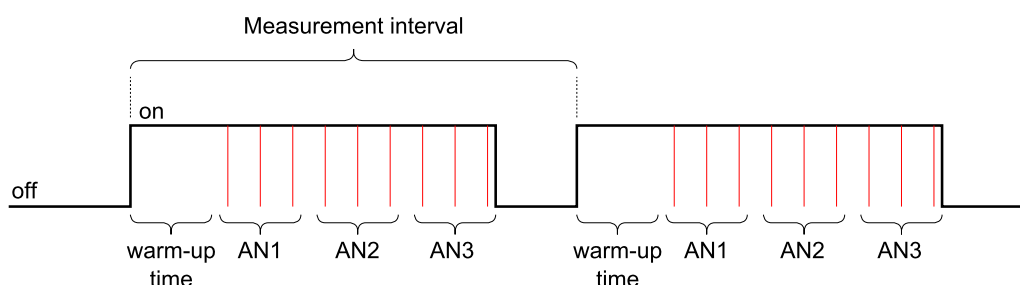

Figure 12 Principal of analog measurements

At the start of each measurement interval the sensor power supply is switched on. After the specified **Warm-up time** each of the three analog inputs is measured sequentially 3x at the sampling rate defined in **ADC - conv. Rate**. After the last measurement has been completed, the sensor power supply is switched off.

The speed of the analog measurements can be set in **ADC - conv. Rate**. If **ADC filter** is active the input is measured 3x and the data logger returns the statistic specified in **ADC filter**.

The measurement interval of all sensors is specified in **Measurement Interval**.

13.2.2 Single ended voltage measurement

A total of four single ended voltages can be measured with the MRL-7. **Figure 13** illustrates the wiring of a temperature and relative humidity sensor for single ended measurements with two analog inputs.

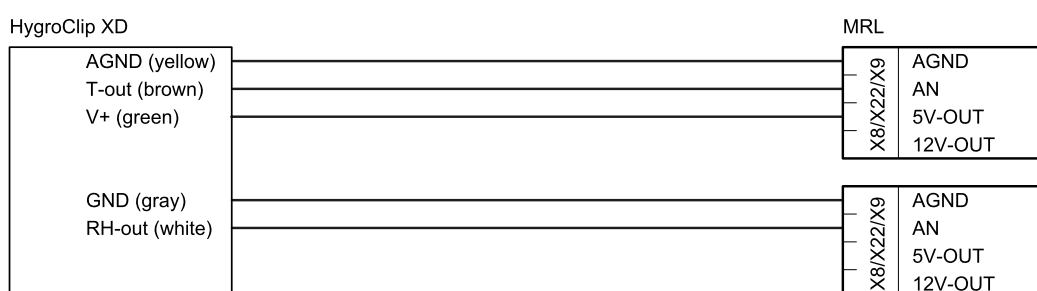

Figure 13 Wiring of single ended voltage measurement (T/rH-sensor)

The T/rH-sensor in this example can be configured in **Measurement table** as follows:

Function	Identifier	Unit	Decimals	Scale	Offset	S-TYP	S-NUM	S-MEA	S-ADD	
01	actual	Air Temperature	°C	2	100	-40	Adjustment	Test	AIN	An1
02	actual	Rel. Humidity	-	1	100	0	Adjustment	Test	AIN	An2

13.2.3 Differential voltage measurement

The analog input AN4 can also be configured as differential input. The wiring of a pyranometer with a 0...100 mV output is illustrated in Figure 14.

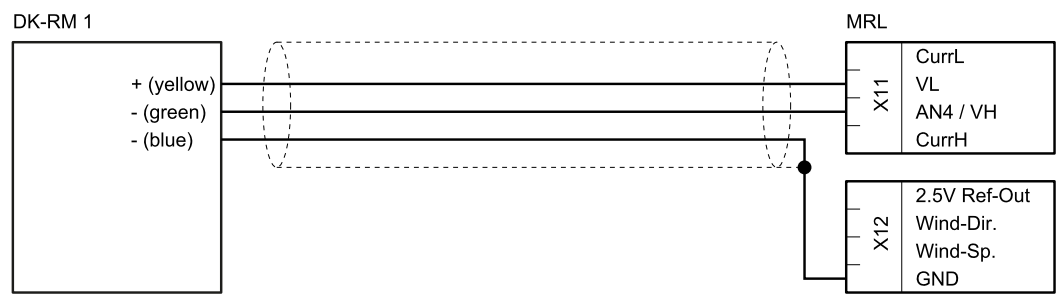

Figure 14 Wiring of differential voltage measurement (pyranometer)

The pyranometer in this example is configured in Measurement table as follows:

Function	Identifier	Unit	Decimals	Scale	Offset	S-TYP	S-NUM	S-MEA	S-ADD	
01	actual	Global Radiation	W/m ²	2	125000	0	Adjustment	Test	AIN	An4 (D)

13.2.4 Current measurement

By adding a precision shunt resistor to one of the analog voltage inputs, sensors with a current output can be measured. As an example, the wiring of a infrared temperature sensor with an output of 4...20 mA and a measurement range of -50...50 °C is illustrated in Figure 15.

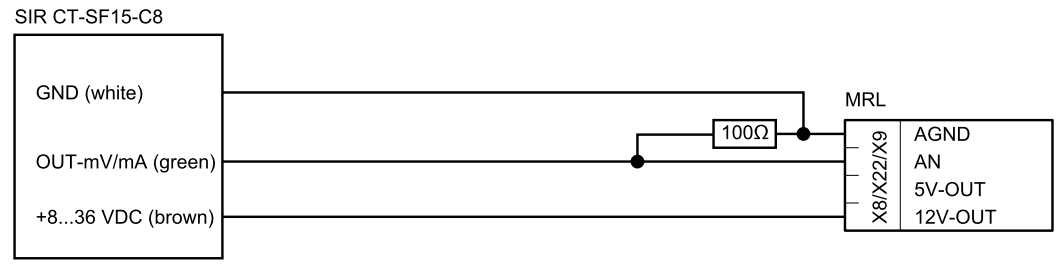
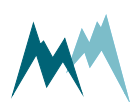

Figure 15 Wiring of sensor with current output (infrared temperature sensor)

The infrared temperature sensor in this example is configured in Measurement table as follows:

Function	Identifier	Unit	Decimals	Scale	Offset	S-TYP	S-NUM	S-MEA	S-ADD	
01	actual	Temperature	°C	2	62.5	-75	Adjustment	Test	AIN	An1



13.2.5 Resistance measurement

The analog inputs AN3 and AN4 can be used to measure resistances. As an example, the wiring of a 4-wire PT1000 temperature sensor is illustrated in [Figure 16](#).

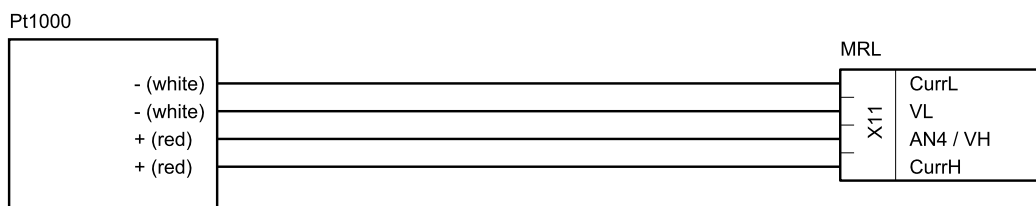

Figure 16 Wiring of resistance measurement (4-wire PT1000)

The PT1000 in this example is configured in [Measurement table](#) as follows:

Function	Identifier	Unit	Decimals	Scale	Offset	S-TYP	S-NUM	S-MEA	S-ADD	
01	actual	Temperature	°C	2	1	0	Adjustment	Test	AIN	An4 (D)

13.3 Counter & frequency measurements

The MRL-7 is equipped with two universal counter inputs and one counter input dedicated to wind speed measurements with an anemometer.

13.3.1 Counting events

The counter inputs 1 and 2 can be used to record counts of different devices. As an example, the wiring of a tipping bucket rain gauge is illustrated in [Figure 17](#).

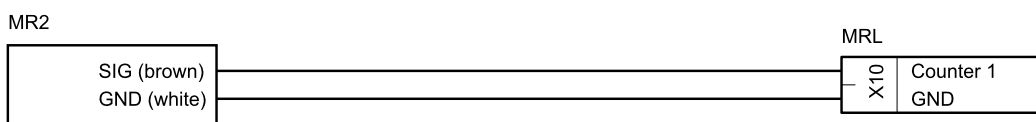

Figure 17 Wiring of a counter input (tipping bucket rain gauge)

The rain gauge in this example is configured in [Measurement table](#) as follows:

Function	Identifier	Unit	Decimals	Scale	Offset	S-TYP	S-NUM	S-MEA	S-ADD	
01	intens.	Precipitation	mm	2	0.2	0	Adjustment	Test	COUNT	Counter 1

Please note, that in this example [Function](#) has to be set to *intensity*. This option sets the counter to 0 if no precipitation is detected.

13.3.2 Frequency measurement

The wind speed input of the MRL-7 – generally used for wind speed measurements – measures the frequency of an incoming signal. [Figure 18](#) illustrates the wiring of a combined wind speed/direction sensor.

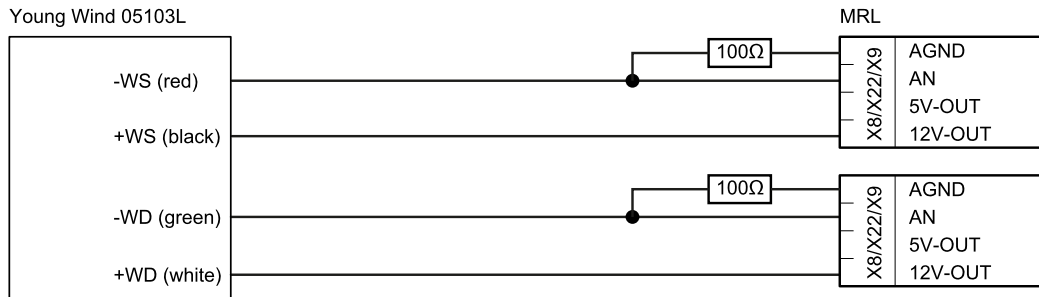

Figure 18 Wiring of a frequency input (combined wind speed/direction sensor)

The wind sensor in this example is configured in [Measurement table](#) as follows:

03	meanval	Wind Speed	m/s	2	0.098	0	Adjustment	Test	WIND	speed
04	maximum	Wind Speed	m/s	2	0.098	0	Adjustment	Test	WIND	speed
05	meanval	Wind Direction	°	1	1.44	0	Adjustment	Test	WIND	direct.

13.4 RS-485

The MRL-7 is equipped with a RS-485 port on terminal block X5 . It is configured in the data logger menu [RS-485-2 Port](#).

13.4.1 Principles

The example below illustrates the acquisition of three measurement values from a digital sensor.

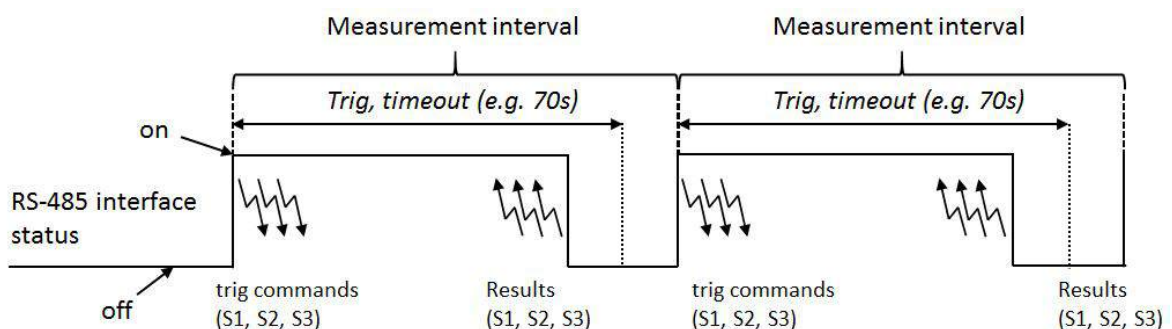
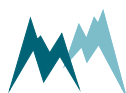

Figure 19 Principal of data acquisition by RS-485

In polling mode the MRL-7 activates the RS-485 interface at the beginning of each measurement interval and sends a measurement command to the addressed sensors. If this command is not



confirmed by a sensor it is re-sent a 2nd or 3rd time. As soon as all measurements have been completed and the requested results have been received after [Trig, timeout](#) has elapsed, the RS-485 interface is switched off automatically and remains idle until the next measurement interval.

13.4.2 Multiple RS-485 devices

As each digital sensor usually has a unique address, multiple Sommer-sensors can be connected to the RS-485 port of the MRL-7.



ATTENTION If multiple Sommer-sensors need to be connected, assign a unique address to each device!

13.4.3 Managing RS-485 devices with Commander

The Commander can be used to connect and manage Sommer RS-485 devices connected to the MRL-7 data logger. Follow the steps below to do this:

1. Connect your RS-485 devices to the RS485A-2/RS485B-2 ports of the MRL-7 and make sure all devices are powered.
2. Establish a connection with the MRL-7 as explained in [Connect the MRL-7 to a PC](#).
3. Define a station as describes in [How to create a station](#).
4. In the [Parameters \(F2\)](#) tab download the parameters of the MRL-7.
5. Set [Network scan extension](#) to *on*.
6. In the [Stations \(F7\)](#) tab click [Scan devices](#). The Commander will now search for all RS-485 devices connected to the data logger and will add them to the station information.

Now, the parameter lists of all devices can be downloaded and the configurations be adapted.

13.4.4 Reading data from a Sommer RS-485 device

Many of Sommer's digital sensors push their measurement data in a specified interval to the RS-485 interface, and the MRL-7 data logger only needs to read these data.

As an example, the SOMMER SQ-U water discharge sensor can be set to measure water discharge at an appropriate interval. The acquired data can be read with the MRL-7 by wiring the data logger according to [Figure 20](#).



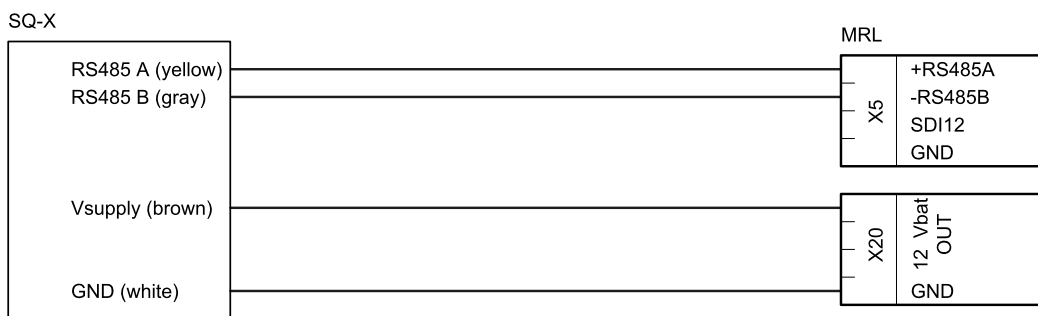

Figure 20 Wiring of SQ-X water discharge sensor with RS-485 interface

The SQ-U in this example is configured in [Measurement table](#) as follows:

Function	Identifier	Unit	Decimals	Scale	Offset	S-TYP	S-NUM	S-MEA	S-ADD		
01	actual	Water level	m	as S	0	Adjustment	Test	SBP	1	2	
02	actual	Velocity	m/s	as S	0	Adjustment	Test	SBP	1	3	
03	actual	Discharge	m ³ /s	as S	0	Adjustment	Test	SBP	1	5	

Additionally, [Trig](#), [polling](#) must be turned off!

NOTE In this example only three variables of the SQ-X are recorded. The device provides an extended list of variables that can be read by the data logger. Alternatively, the SQ-X can be set to polling mode and the MRL-7 to request the measurements.

13.4.5 Reading data in MIO-format

Some older Sommer sensors like the USH-8 send data in the MIO-format (multi-in-out) which is structured as in the following example:

```
I04124874-011350148960519;
```

	Format	Description
Identifier	I	I identifies an output string
Device number	04	
System key	12	
Measurement value 1	4874	Level in mm (4 digits)

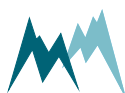

	Format	Description
...	...	Measurement values 2...4 (4 digits each)
Checksum	0519	
End character	;	

To read data strings in MIO-format [Measurement table](#) has to be configured as follows:

Function	Identifier	Unit	Decimals	Scale	Offset	S-TYP	S-NUM	S-MEA	S-ADD		
01	actual	Level	mm	as S	0	Adjustment	Test	MIO	4	1	

In this example the first measurement value (level) is read from device 04.



ATTENTION The system keys of the sensor and the MRL-7 must be the same! In the example above the system key is 12. Set [System key](#) of the MRL-7 to 12 as well, or adapt the key of the sensor.

13.4.6 Polling data from a Sommer RS-485 device

Various sensing devices perform measurements autonomously and send out the results on request. The SOMMER IDS-20 Ice detection system is an example of such a device. It detects icing of a surface with a capacitive transducer and is used, for example, in the wind industry and in aviation to detect ice loads and icing events. The IDS-20 performs measurements autonomously at an interval of 60 seconds. The acquired data can be polled with the MRL-7 by wiring the data logger according to [Figure 21](#).

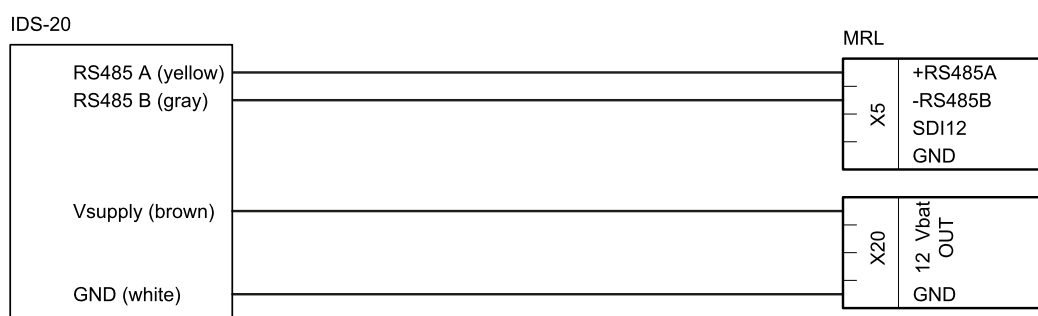

[Figure 21](#) Wiring of IDS-20 ice detection sensor with RS-485 interface

The IDS-20 in this example is configured in [Measurement table](#) as follows:

Function	Identifier	Unit	Decimals	Scale	Offset	S-TYP	S-NUM	S-MEA	S-ADD	
01	actual	Ice	mm	as S	0	Adjustment Test	SBP	1	7	TD
02	actual	Ice rate	mm/h	as S	0	Adjustment Test	SBP	1	9	
03	actual	Dep point	°C	as S	0	Adjustment Test	SBP	1	3	

Please note the command TD in the S-ADD field: this command requests the data from the IDS-20 device and needs to be set in the first variable acquired from the sensor. Additionally, Trig, polling must be turned on!

Note that in this example only three variables of the IDS-20 are recorded. The device provides an extended list of variables that can be polled by the data logger.

If a connected sensor also requires a command to trigger a measurement and returns the measured data automatically Trig, polling needs to be on as well, but no TD command is required.

ATTENTION The response time of different digital sensors varies considerably. Please consult the sensor manual and adjust Trig, timeout accordingly!

13.5 SDI-12

SDI-12 (Serial Data Interface at 1200 Baud) is a serial data communication standard for interfacing multiple sensors with a single data recorder.

The MRL-7 is equipped with a SDI-12 port on terminal block X5. SDI-12 bus mastering offers some helpful functions to query SDI-12 sensor addresses and to test communication.

13.5.1 Principles

The example below illustrates how the MRL-7 triggers the measurements and requests the results from three SDI-12 sensors.

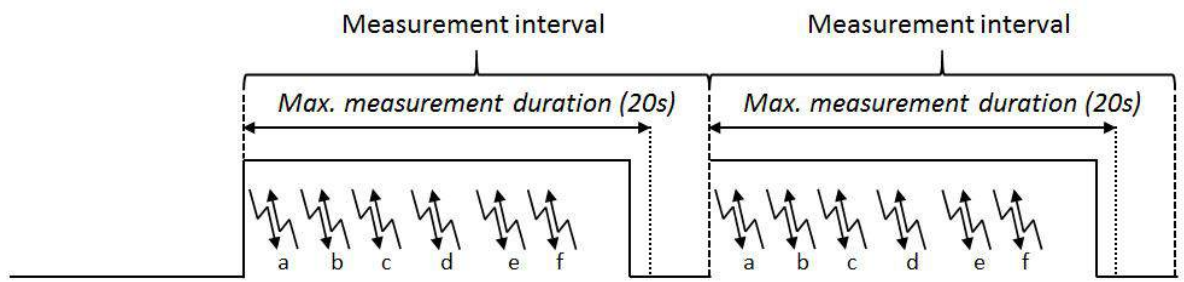

The commands and the received responses are as follows:

1. 0M! 00013<CR><LF> 3 values are available in 1 second
2. 0D0! 0+1.1+2.2+3.3><CR><LF> 3 values: 1.1, 2.2, 3.3

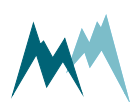

3.	1M!	10022<CR><LF>	2 values are available in 2 seconds
4.	1D0!	1+4.4+5.5<CR><LF>	2 values: 4.4, 5.5
5.	2M!	20031<CR><LF>	1 value is available in 3 seconds
6.	2D0!	2+6.6<CR><LF>	1 value: 6.6

Figure 22 Principle of data acquisition by SDI-12

At the beginning of each measurement interval the MRL-7 sends an M! command to the first sensor. The sensor answers by returning the number of available measurements and the measurement duration. After the required measurement time the MRL-7 sends a D! command to request the measurement results. This sequence is repeated for the other two sensors before the next measurement interval starts.

For a detailed description on SDI-12 communication please refer to www.sdi-12.org.

13.5.2 Measurements with an SDI-12 sensor

An SDI-12 sensor is wired to the MRL-7 as shown in Figure 23.

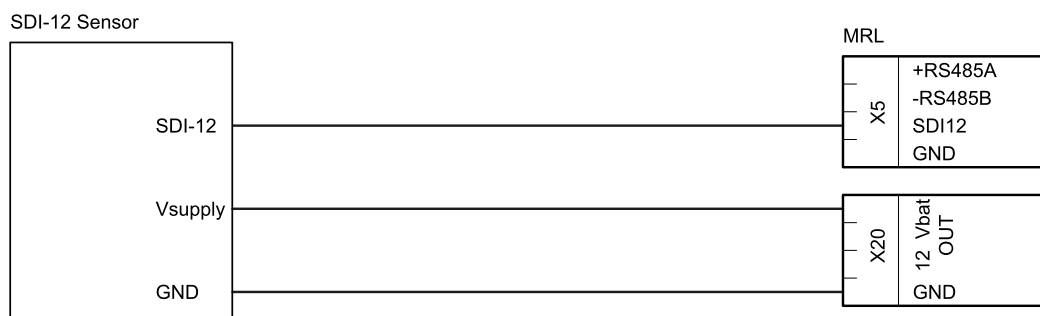

Figure 23 Wiring of a SDI-12 sensor

An SDI-12 sensor is configured in [Measurement table](#) as in the following example:

	Function	Identifier	Unit	Decimals	Scale	Offset		S-TYP	S-NUM	S-MEA	S-ADD	
01	actual	Water Level	m	as S		0	Adjustment	Test	SDI12	1	2	
02	actual	Velocity	m/s	as S		0	Adjustment	Test	SDI12	1	3	
03	actual	Discharge	m ³ /s	as S		0	Adjustment	Test	SDI12	1	5	

To enable data acquisition via SDI-12, **S-TYP** has to be set to *SDI12*, **S-NUM** to the SDI-12 address of the sensor and **S-MEA** to the position of the required measurement value in the data string.

To check the correct wiring between the MRL-7 and SDI-12 sensors, and to request the addresses of these sensors click on [Sensor search](#) in the [SDI-12 bus mastering](#) menu. This function then searches for any connected SDI-12 sensors and lists their addresses and identifications. To change a sensor address click [Change sensor address](#).



NOTE Make sure [Max. measurement duration](#) is long enough to capture the SDI-12 measurement. If a sensor requires a warm-up time the measurement duration may increase considerably.

13.6 How to view live data

The current measurements performed by the MRL-7 can either be viewed on the LCD-display of the data logger (see [Displaying the last measurement values](#)) or with the Commander by following the steps below:

1. Establish a direct or remote connection with the MRL-7 using the Commander (see [Connect the MRL-7 to a PC](#) and [Remote access](#) for details). Use an existing Commander-connection or -station if available.
2. In the [Parameters \(F2\)](#) tab download the parameters of the MRL-7.
3. Now, there are two options to view the measurement data:
 1. If [OP, measurement output](#) is set to *measured automatic*, data are displayed in the [Measurement \(F3\)](#) tab in the specified measurement interval.
 2. Open the [Measurement \(F3\)](#) tab and click [Start polling measurements](#). With this option measurements are triggered in the fastest possible sequence and the results are displayed instantly. This measurement mode can be stopped by clicking [Stop polling](#), or it is finished automatically after 30 minutes.

13.7 How to collect data

Measurement data are automatically stored on the MRL-7 in the defined [Storage interval](#) on the internal flash memory and/or a mounted MicorSD card. Alternatively, data can be transmitted regularly to a remote data server (see [Data transmission](#)) or stored manually on a USB flash drive (see [How to copy data to a USB flash drive](#)).

13.7.1 Collecting data with Commander

Data of a MRL-7 can also be collected with the Commander software by performing the following steps:

1. Establish a direct or remote connection with the MRL-7 using the Commander (see [Connect the MRL-7 to a PC](#) and [Remote access](#) for details). Use an existing Commander-connection or -station if available.
2. If no station has been defined for your data logger, create one as described in [How to create](#)

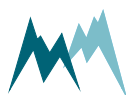

a station.

3. Open the **Data (F4)** tab and select your station.
4. Click **Transfer data manually**. In the pop-up window the available data are displayed by the timestamps on the left and right, which correspond to the oldest and most recent data records. Move the slider to the time from which data need to be collected and press **OK**. Depending on the number of records to be downloaded this may take a few seconds or several minutes.

The downloaded data are stored as csv-files in the default installation path of the Commandersoftware, generally C:\Users\Public\Documents\Sommer\Data, or in a subfolder as specified in the station (**Archive subfolder** in **Station settings**).



NOTE If a station has been defined, data since the last transfer can be downloaded.

5. After download is complete, the data are displayed in the graph of the **Data (F4)** tab. See [How to view collected data](#) for some features of the graph-tool.

13.8 How to view collected data

Collected data are stored in the SommerXF format, a semicolon-delimited csv-file, which can be viewed with any text editor or spreadsheet tool.

13.8.1 Viewing data with Commander

Data collected from any MRL-7 data logger can be viewed by opening the **Data (F4)** tab and clicking **Open data file** to select the file you want to view. The data are now loaded and displayed in the graph.

Several actions can be used to navigate within the graph:

- Select a data window by pressing the right mouse button and spanning a rectangular box.
- Select a certain time range by moving the mouse over the time axis with the right mouse button pressed.
- Select a certain value range by moving the mouse over the value axis with the right mouse button pressed.
- View all data by pressing the right mouse button within the graph pane.

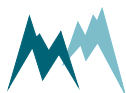

14 Parameter definitions

A	Station ID	98
B	Station name	98
C	Measurement Interval	98
D	Storage interval	98
E	Measurements, max. number	99
F	Aux measurements, max. number	99
G	Measurement table	99
H	Messages, table	107
I	Modem	109
J	Technics	117
K	Special functions	135

A Station ID

By default, the station ID is set to the MRL-7 serial number. Adjust to your requirements if needed.

Value range	Default	Unit
0...99'999'999	00'000'000	-

B Station name

The name of the Station (max. 32 characters long).

C Measurement Interval

The interval at which measurements are acquired.

Unit	sec	seconds
Value range	00:00:01 ... 12:00:00	00:01:00 (default)

D Storage interval

The interval at which acquired measurements are stored in flash memory or microSD-card.

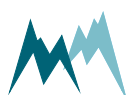

Value range	Default	Unit
00:00:01 ... 12:00:00	00:05:00	-

E Measurements, max. number

The number of variables the MRL-7 records. If the MRL-7 is shipped with additional instruments, SOMMER Messtechnik pre-configures the required variables. The variables are configured in [Measurement table](#) and their number can be increased to 80.

Value range	Default	Unit
1 ... 80	20	-

F Aux measurements, max. number

The number of auxiliary variables the MRL-7 records. Auxiliary variables are configured like regular variables, except that they are not stored in memory and are only visible in the Commander [Measurement](#) tab, the terminal window or the logger display. In [Measurement table](#) they are numbered downwards from 99. Auxiliary variables may be used to monitor limit violations, trigger messages or to display a variable with a second, different unit.

Value range	Default
1 ... 99	0

G Measurement table

In the measurement table the required variables and any auxiliary variables are configured. The measurement table can have up to 99 entries. Each entry is configured by the parameters described below:

Function

Defines the output type of the variable. The following options are available:

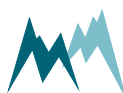

Function	Description
off	The variable is not recorded and stored.
actual	The last value acquired within the storage interval is recorded and saved.
meanval	The average of all values acquired within the storage interval is recorded and saved.
minimum	The minimum of all values acquired within the storage interval is recorded and saved.
maximum	The maximum of all values acquired within the storage interval is recorded and saved.
sum	The sum of all values acquired within the storage interval is recorded and saved.
intens.	Same as <i>diff</i> , but accepts only positive values.
diff.	The difference of the last values acquired in consecutive storage intervals is recorded and saved.
custom1	not available
custom2	not available

Identifier

User defined variable name.

Unit

The unit of the selected variable.

Decimals

The number of decimal places assigned to the selected variable. The following options are available:

Decimals	Description
1...5	number of decimal places assigned to the selected variable
none	no decimal places
as S	the number of decimal places of the source is adopted

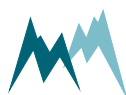
Scale

The slope applied to the selected variable. Only available if **Decimals** is set to 1...5 or none. If **Decimals** is set as S (as source), no scaling is applied.

Offset

The offset applied to the selected variable.

Adjustment

A measurement of the selected variable is triggered and the result displayed in the terminal window. If the measured value deviates from the correct value, the correct value can be entered. This adjusts the value in **Offset**. The factor in **Scale** is not affected by this correction.

Test

A measurement of the selected variable is triggered and the result displayed in the terminal window.

S-TYP

One of the following sensor (or source) types:

S-TYP	Description and S-MEA options
AIN	Analog input The input port is set in S-MEA with the following options: AN1 Analog input 1 AN2 Analog input 2 AN3 (N) Analog input 3 AN4 (D) Analog differential input
WIND	Wind sensor The input is set in S-MEA with the following options: speed Wind speed direct. Wind direction
COUNT	Counter input Counter 1 Counter input 1 Counter 2a Counter input 2-a Counter 2ab Counter input 2-ab

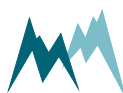

S-TYP	Description and S-MEA options
SDI12	<p>SDI-12 input</p> <p>The sensor address is set in S-NUM, and the position of the measurement value within the output string is assigned in S-MEA.</p> <p>Example: SDI-12 sensor with an output string 0 . 0 + 6 . 5 + 4 . 3 + 2 . 1 + ... To retrieve the value 6 . 5, S-MEA must be set to 1 and to retrieve the value 4 . 3, S-MEA must be set to 2.</p>
SBP	<p>SOMMER sensor that supports the SBP-protocol (via RS-485)</p> <p>The sensor address is set in S-NUM, and the position of the measurement value within the output string is assigned in S-MEA (see Measurements & data acquisition for an example).</p>
MIO	<p>SOMMER sensor that supports the MIO-protocol (via RS-485)</p> <p>The sensor address is set in S-NUM, and the position of the measurement value within the output string is assigned in S-MEA (see Measurements & data acquisition for an example).</p>

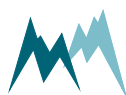

S-TYP	Description and S-MEA options
GPS	Output of the integrated GPS-receiver (only available in MRL-7GPS)
Long	The longitude of the data loggers position
Lat	The latitude of the data loggers position
Altitude	The altitude of the data loggers position
Sat	The number of satellites in view of the GPS-receiver
 ATTENTION Modem functionality must be <i>on</i> for use of GPS-functionality!	

S-NUM

The number of the selected SDI-12 or RS-485 sensor, e.g. 3. Valid values for the SDI-12 address are 0...9, a...z and A...Z. The RS-485 device address may take a value 1...98.

S-MEA

The position of the measurement value within the string returned by a connected digital sensor, the name of an internal system variable, or the connection port of the selected analog sensor. See S-TYP for the available options.

S-ADD

Contains additional commands which are sent with a standard request to a sensor (or source), or which provide additional options for controlling measurements and handling results. The available commands depend on the settings in S-TYP:

Function	S-TYP	S-ADD	Description
SUM	all	NR	No reset of summed variables at daily reset event
		MR	Monthly reset of summed variables
		DD	Double data for summed variables at reset event; old and new values are stored
		TR	Threshold reset: for summed variables with Limit; sum is reduced by limit after limit violation

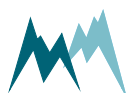

Function	S-TYP	S-ADD	Description
all	SDI12	_Cn	Concurrent measurement command for measurement cycle <i>n</i>
		CCn	Concurrent measurement command with CRC for measurement cycle <i>n</i>
		_Mn	Measurement command for measurement cycle <i>n</i>
		MCn	Measurement command with CRC for measurement cycle <i>n</i>
		_Rm	Read command for data <i>m</i>
		RCm	Read command with CRC for data <i>m</i>
			n... Number of SDI-12 measurement cycle m... Number of SDI-12 output line
all	SBP, MIO	SCx	Subchannel for MDL compatibility
		TD	Trigger data of a SBP or MIO device
	MIO	TF	Trigger fake
	COUNT	SW	Switched direction of shaft/impuls encoder

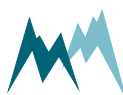

Function	S-TYP	S-ADD	Description
all	all	SY	Synchronous storage: variable that is normally stored asynchronously is stored in the main storage interval.
		AS	Asynchronous storage: variable that is normally stored synchronously is stored in the Occasional storage interval .
		SXaa	auxiliary storage interval: where aa is the auxiliary interval to use
		ST	Triggers an action if the measurement value falls BELOW the specified limit set in Limit
		MAxx	Moving average of xx values, where xx is 5, 12, 24, 48, 96
		EX	Exponential: value is put to the power of e
		PT $\gamma \cdot \gamma$	Potential: value is put to the power of $\gamma \cdot \gamma$
all	RECYC, RECYCM	D+	Adds variables referenced in S-NUM and S-MEA
		D-	Subtracts variable referenced in S-MEA from S-NUM
		GS	Limit status of the recycled variable
	RECYCM	D*	Multiplies variables referenced in S-NUM and S-MEA
		D/	Divides variable referenced in S-NUM by S-MEA
		DM	Stores current value of variable referenced in S-MEA if variable in S-NUM reaches a maximum or minimum. Generally used to record wind direction of wind gusts.

 **TIP** Multiple commands can be entered by separating them with commas, e.g. D+, SY.

Limit

Optional limit value. By default, the measurement value must exceed the limit to trigger an action. Add the command ST in [Measurement table](#) to trigger an action if the measurement value falls below the limit.

Messages

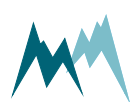

The action to be performed if the measurement value exceeds or falls below the limit set in [Limit](#). The actions are specified in [Messages, table](#) and are referenced by their message number. Multiple actions can be selected.

H Messages, table

The MRL-7 features a configurable messaging system. Messages are transmitted to defined recipients whenever a measurement value exceeds or falls below a limit specified in [Measurement table](#).

In the messages table up to 16 messages can be configured. Each entry is configured by the parameters described below:

Message

Defines the type of the message. The following options are available:

Message	Description
off	No message is sent.
Switch	A switch output is closed if a trigger condition is satisfied.
E-Mail	An E-mail is sent to a defined recipient if the trigger condition is satisfied. Not available with MRL-7 O-Versions.
text	A SMS message is sent to a defined recipient if the trigger condition is satisfied. Not available with MRL-7 O-Versions.

Recipient

Either the E-mail address or the phone number of the recipient. Country codes of phone numbers are preceded either by 00 or +, e.g. 0049 or +49 for Germany.

Subject

Subject of the e-mail message, max. 80 characters long. The subject may include content codes as listed in [Table 18](#).



Content

The content of the e-mail or SMS message, max. 160 characters long. The content may include content codes as listed in [Table 18](#).

Switch

The switch output to be used. Up to three outputs can be selected.

Hold

The time in seconds the selected switch is closed after a limit violation has occurred. If 0 seconds is entered, the switch is closed as long as the limit value is violated.

Code	Description
%sid%	Station ID assigned to the MRL-7
%sname%	Station name assigned to the MRL-7
%cname%	Name of the channel that triggered the message
%cunit%	Unit assigned to the channel that triggered the message
%time%	Time of message transmission
%date%	Date of message transmission
%cval%	Last measurement result acquired before message transmission
%tval%	Limit value that was crossed
%rval%	Measurement result that triggered the message
%wnum%	Message number (01...16)
%cp%	Measurement result of a user defined channel.

Table 18: Content codes



EXAMPLE

Channel number 02 triggers an e-mail message. This message shall contain

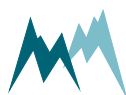



the channel name and value of the measurement result that triggered the message and additionally the current result of channel number 14. The corresponding message is written as:

```
%cname% %rval% Ch.14 m.value = %cp14%
```

I Modem

I-A	Modem functionality	109
I-B	Modem config	109
I-C	Data transmission 1	112
I-D	Data transmission 2	114
I-E	Data transmission 3	114
I-F	Synchronization time	114
I-G	NTP server	115
I-H	NTP port	115
I-I	Time zone	115
I-J	Background function	115
I-K	Standby, start time	115
I-L	Standby, duration	116
I-M	IP Call server	116
I-N	IP Call port	116
I-O	IP Call interval	116
I-P	E-mail/SMTP	116

I-A Modem functionality

Setting	Description
on	Modem is active
off (default)	Modem is inactive

I-B Modem config

I-B-A	SIM pin	110
I-B-B	Net type	110
I-B-C	Foreign operator mcc&mnc	110
I-B-D	Operator select	111
I-B-E	APN address	111

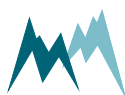

I-B-F	APN username	111
I-B-G	APN password	111
I-B-H	Custom command 1	111
I-B-I	Custom command 2	111

I-B-A SIM pin

The PIN of the SIM card. If set to -1, no PIN is required.

Value range	Default	Unit
-1...9'999	-1	-

The PIN cannot be changed with the MRL-7. Use a different device, e.g. mobile phone, for this task.



ATTENTION If the wrong PIN is entered, the SIM card will be locked after three consecutive attempts to transfer data.

I-B-B Net type

The telecommunication standard used for data transmission.

Setting	Description
auto (default)	The telecommunication network is selected automatically.
3G	Only 3G telecommunication networks are used to transfer data.
2G	Only 2G telecommunication networks are used to transfer data.
4G	Only 4G telecommunication networks are used to transfer data.
auto (US + CA)	The telecommunication network is selected automatically. Applies to the US and Canada only.

I-B-C Foreign operator mcc&mnc

The mobile country code and mobile network code for your home network in case your provider is a virtual one. If blank, this setting is inactive (default).

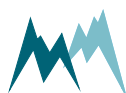

I-B-D Operator select

The network operator to be used.

Setting	Description
auto (default)	The network operator is selected automatically.
home	Only the SIM card's home network is used.
Prefer home	Preferably, the home network of the selected operator is chosen. If no connection can be established with the home network, another operator is selected automatically.

I-B-E APN address

The APN of your carrier's mobile network. The APN can be selected from a list displayed with [Select APN](#) in the Commander menu [Special commands](#).

I-B-F APN username

The APN username.

I-B-G APN password

The APN password.

I-B-H Custom command 1

AT command sent to the modem, e.g. [AT+CSQ](#) to query the radio signal strength. The escape characters listed in [Escape characters](#) may be used.

All AT commands must be answered with an [OK](#) by the connected modem. Use this function only if you are familiar with AT commands.

I-B-I Custom command 2

See [Custom command 1](#).

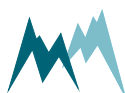

I-C Data transmission 1

I-C-A	Target server type	112
I-C-B	Data transmission interval	112
I-C-C	Data transmission offset	112
I-C-D	Content	113
I-C-E	FTP server name	113
I-C-F	FTP user name	113
I-C-G	FTP password	113
I-C-H	FTP directory	113
I-C-I	FTP port	113
I-C-J	FTP mode	114
I-C-K	HTTP server name	114
I-C-L	HTTP path	114
I-C-M	HTTP port	114

I-C-A Target server type

The type of server to which the data are sent to.

Setting	Description
off (default)	No data are transmitted.
http	Data are sent to a HTTP server (HTTP settings are used)
ftp	Data are sent to a FTP server (FTP settings are used)

I-C-B Data transmission interval

The interval in which data are transmitted to the selected server.

Value range	Default	Unit
00:01:00 ... 24:00:00	00:10:00	-

I-C-C Data transmission offset

The data transmission offset is used to prevent several MRL-7 from sending their data to the same server at the same time. Thus, set different transmission offsets when using several MRL-7 with the

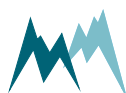

same server.

Value range	Default	Unit
00:00:00 ... 23:59:59	00:01:09	-

I-C-D Content

The type of data to be transmitted.

Setting	Description
data (default)	Measurement data are transmitted.
camera	Pictures of a connected camera are transmitted.

I-C-E FTP server name

The FTP name or server address.

I-C-F FTP user name

The username of your FTP server account. The escape characters listed in [Appendix B](#) may be used.

I-C-G FTP password

The password of your FTP server account. The escape characters listed in [Appendix B](#) may be used.

I-C-H FTP directory

The FTP directory where the data are saved. If empty, data are saved to the FTP root directory. The escape characters listed in [Appendix B](#) may be used.

I-C-I FTP port

The FTP server port. Default is [21](#).



I-C-J FTP mode

The FTP server mode.

Setting	Description
active	active FTP
passive (default)	passive FTP

I-C-K HTTP server name

The HTTP name or server address.

I-C-L HTTP path

The HTTP request, URL or script by which the data are saved. The escape characters listed in [Appendix B](#) may be used.

I-C-M HTTP port

The HTTP server port. Default is *80*.

I-D Data transmission 2

See [Data transmission 1](#).

I-E Data transmission 3

See [Data transmission 1](#).

I-F Synchronization time

The time at which the clock of the MRL-7 is synchronized.

Value range	Default	Unit
00:00:00 ... 23:59:59	02:08:43	-

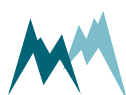

I-G NTP server

The address of the NTP server. Default is *mds.sommer.at*.

I-H NTP port

The NTP port of the NTP server. Default is 123.

I-I Time zone

The offset in seconds of the local time to UTC. For example, a local time of UTC+1 is entered as *3600* sec.

Value range	Default	Unit
43'200 ... 43'200	3'600	sec

I-J Background function

Specifies the management of communication requests.

Setting	Description
off (default)	The MRL-7 does not accept remote connections.
time window	The MRL-7 accepts IP-calls and Socket requests in the time window specified by <i>Standby, start time</i> and <i>Standby, duration</i> . <i>Net type</i> must be set to 2G.
time wi. + IP call	The MRL-7 accepts CSD calls in the time window specified by <i>Standby, start time</i> and <i>Standby, duration</i> , and checks periodically for IP call requests. <i>Net type</i> must be set to 2G.
time wi. + socket	The MRL-7 accepts CSD calls in the time window specified by <i>Standby, start time</i> and <i>Standby, duration</i> , and listens on its IP address with port 4646 for requests.

I-K Standby, start time

The time of day from which the MRL-7 is available for remote communication (CSD calls, IP calls).



Value range	Default	Unit
00:00:00 ... 23:59:59	08:00:00	-

I-L Standby, duration

The time for which the MRL-7 is available for remote communication (IP-calls and Socket requests).

Value range	Default	Unit
00:00:00 ... 23:59:59	01:00:00	-

I-M IP Call server

The name or address of the IP call server. Default is *mds.sommer.at*.

I-N IP Call port

The port of the IP call server. Default is *4647*.

I-O IP Call interval

The interval at which the MRL-7 checks if there are any IP call requests. These checks are only performed within the time window specified by *Standby, start time* and *Standby, duration*.

Value range	Default	Unit
00:01:00 ... 00:05:00	00:01:00	-

I-P E-mail/SMTP

- I-P-A E-mail/SMTP117
- I-P-B Sender117
- I-P-C Username117
- I-P-D Password117
- I-P-E Port117

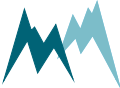

I-P-A E-mail/SMTP

The name or address of the E-Mail server used by the MRL-7 to send e-mails, e.g. *smt-p@emailprovider.com*.

I-P-B Sender

E-mail address of the MRL-7, e.g. *sender.name@emailprovider.com*.

I-P-C Username

Username of your e-mail server account (if requested by the server).

I-P-D Password

Password of your e-mail server account (if requested by the server).

I-P-E Port

The e-mail server port. Default is 25.

J Technics

J-A	Language/Sprache	117
J-B	Decimal character	118
J-C	Additional settings	118
J-D	Additional timings	121
J-E	Com-1 protocol	123
J-F	Com-1 port	125
J-G	RS-485-2 Port	126
J-H	SDI-12 bus mastering	130
J-I	Analog setup	131
J-J	Camera	134

J-A Language/Sprache

The menu language.

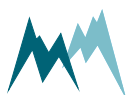

Option	Description
german/deutsch	German language
english/englisch (default)	English language

J-B Decimal character

The character used as decimal separator in the values of the settings and in serial data strings.

Option	Description
comma	-
dot (default)	-

J-C Additional settings

J-C-A	Sommer ID	118
J-C-B	Block size, data load	118
J-C-C	Internal low volt. Disconnect	119
J-C-D	SommerXF starts with BOM	119
J-C-E	Exposure lock	119
J-C-F	LCD, Contrast	120
J-C-G	LCD, Brightness	120
J-C-H	Wind speed measurement duration	121

J-C-A Sommer ID

The Sommer ID is used to define stations within the Commander software. The ID is preset in the device and corresponds to its serial number. SOMMER suggests not to change the ID, except if a MRL-7 device is replaced. In such a case it can be practical to change the ID of the new device to the ID of the replaced device to guarantee data consistency.

J-C-B Block size, data load

The amount of data transferred by one communication block over the serial interface.

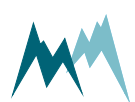

Value range	Default
50...250	250

J-C-C Internal low volt. Disconnect

To prevent deep discharge of the MRL-7 batteries, the device switches off if the battery voltage drops below the specified limit. It then checks every hour if the battery has recuperated again and eventually switches back to normal measurement mode. The limit depends on the battery used; consult the battery datasheet for more information.

Value range	Default	Unit
5.0...11.0	10.5	V



ATTENTION Inappropriate setting of the voltage limit can seriously impair the continuous operation of the MRL-7!

J-C-D SommerXF starts with BOM

The BOM (Byte Order Mark) labels the downloaded data file to indicate that special characters within the file are coded.

Setting	Description
on (default)	BOM is returned.
off	BOM is not returned.

J-C-E Exposure lock

Sets data visibility on the MRL-7 display.



Setting	Description
off (default)	Measurement data are displayed.
display	Measurement data are displayed only after access code has been entered.
display + data	Measurement data are displayed only after access code has been entered. Additionally, downloading data to a connected flash drive requires the access code.

 **ATTENTION** As long as the display is active, the entered access code keeps all system settings of the logger unlocked!

J-C-F LCD, Contrast

The contrast of the LCD-display.

Setting	Description
weak	low contrast
base (default)	base contrast
medium	medium contrast
high	high contrast

J-C-G LCD, Brightness

The MRL-7 is equipped with an integrated ambient light sensor that is used to automatically adjust the display brightness.

If the light intensity is below the specified value, the backlight brightness is automatically adjusted to a suitable level. If the value is exceeded, the display backlight is switched off.

Value range	Default	Unit
0...3000	40	lm

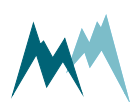

J-C-H Wind speed measurement duration

The time for measuring the wind speed with a connected anemometer.

Value range	Default	Unit
500...2000	1000	ms

J-D Additional timings

J-D-A	Sum, reset time	121
J-D-B	Occasional storage interval	121
J-D-C	Sync date (last)	122
J-D-D	Sync time (last)	122
J-D-E	Min. Hold on message	122
J-D-F	max. Hold on message	122
J-D-G	Hold commander	122
J-D-H	Main Switch reset	123
J-D-I	Logger reboot time	123

J-D-A Sum, reset time

Time at which the sums of summed variables defined in [Measurement table](#) are reset to zero.

Value range	Default	Unit
00:00:00 ... 23:59:59	07:00:00	-

J-D-B Occasional storage interval

Storage interval of variables which are only stored at the time when their value changes. Counter variables and certain system variables are stored by default in this interval. By adding the command `SŸ` in [Measurement table](#), the variable is forced to be stored in the primary storage interval.

Value range	Default	Unit
00:00:00 ... 23:59:59	00:01:00	-

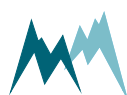

J-D-C Sync date (last)

The date at which the MRL-7 date is manually synchronized to the Commander date; read only. This date is saved automatically for traceability.

J-D-D Sync time (last)

The time at which the MRL-7 time is manually synchronized to the Commander time; read only. This time is saved automatically for traceability.

J-D-E Min. Hold on message

The time, after a limit violation, for which a message or switch action is valid. For example, if a value of five minutes is entered, and the wind speed of a connected anemometer exceeds the limit value repeatedly within these five minutes, no additional message is sent. Used to suppress multiple messages if variable fluctuates around the limit value.

Value range	Default	Unit
0 ... 180	5	min

J-D-F max. Hold on message

The time over which a limit has to be violated before another message is sent. For example, if a value of 60 minutes is entered, and the wind speed of a connected anemometer still exceeds the limit value after 60 minutes, another SMS-warning is sent.

A value of zero deactivates this function.

Value range	Default	Unit
0 ... 120	0	min

J-D-G Hold commander

Time between the last RS-232 communication and the switch-off of the interface. After switch-off a wake-up sequence activates the interface again.

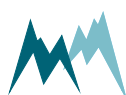

Value range	Default	Unit
1 ... 30	8	sec

J-D-H Main Switch reset

If activated, the 12-V power supply of the X20 terminal is switched off and on again daily at **Sum, reset time**. Generally used to reset connected sensors.

Setting	Description
off (default)	Reset is not active
10 sec	Power supply of X20 terminal is switched off for 10 seconds
30 sec	Power supply of X20 terminal is switched off for 30 seconds

J-D-I Logger reboot time

Sets the daily reboot of the data logger. Deactivated if nothing is entered.

Setting a daily reboot is recommended for remote stations where the mobile network may drop the modem into an undefined communication state.



NOTE Enabling daily reboot may lead to some data loss if the measurement interval is less than a few minutes.

Value range	Default	Unit
00:00:00 ... 23:59:59		-

J-E Com-1 protocol

J-E-A	Device number	124
J-E-B	System key	124
J-E-C	Output protocol (OP)	124
J-E-D	OP, measurement output	124
J-E-E	OP, wake-up sequence	125
J-E-F	OP, prefix holdback	125

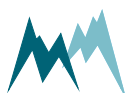

J-E-A Device number

The device number is used for the unique identification of the device in a bus system.

Value range	0...98	1 (default)
-------------	--------	-------------

J-E-B System key

The system key defines the bus system of the device. Thus, different conceptual bus systems can be separated. Interfering bus systems occur if the remote radio coverage of two measurement systems overlap. In general, the system key should be set to 00.

Value range	0...99	0 (default)
-------------	--------	-------------

J-E-C Output protocol (OP)

The type of the serial output protocol. The following options are available:

Option	Description
Sommer (default)	Sommer protocol; data values are returned with an index starting at 1
Standard	Standard protocol; data values are returned without an index

J-E-D OP, measurement output

Specifies the timing of the serial data output.

Option	Description
just per command	The output is only requested by commands via the RS-485 or SDI-12 interface.
measured values push	Data are returned automatically after each measurement.
storage values push	Data are returned automatically after they have been written to the data logger memory.

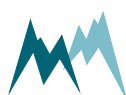

J-E-E OP, wake-up sequence

Serial data can be transmitted to a recording device automatically without a request. However, many devices demand a wake-up sequence before they can receive and process data. The MRL-7 has the option to send a sync sequence and a prefix before data are transmitted (see [Waking-up a connected data logger](#)). The following options are available:

Option	Description
off	No wake-up sequence
sync	The sync sequence UU~?~? is sent before the output string.
prefix (default)	A blank with a time delay is sent before the output string.
prefix & sync	A blank with a time delay and the sync sequence UU~?~? is sent before the output string.

J-E-F OP, prefix holdback

The hold-back time defines the time delay between the prefix and the data string.

Unit	ms	Milliseconds
Value range	0...5'000	300 (default)

J-F Com-1 port

J-F-A	Baud rate	125
J-F-B	Minimum response time	126
J-F-C	Flow control	126

J-F-A Baud rate

The following transmission rates in bps (baud) can be selected:

1'200



2'400
4'800
9'600 (default)
19'200
38'400
57'600
115'200

J-F-B Minimum response time

Setting of this parameter avoids interference of communication at the RS-485 interface. For this purpose the response to a command is delayed by the selected time. Additionally, the response is kept compact.

Unit	ms	Milliseconds
Value range	0...2'000	10 (default)

J-F-C Flow control

The XOFF-XON flow control can be activated with this setting.

Option	Description
Off (default)	no flow control
XOFF-XON blocking	XOFF-XON flow control, especially adapted for half-duplex systems

J-G RS-485-2 Port

The RS-485-2 interface is used to read data from connected digital sensors. The following parameters are available to configure it.

- J-G-A Baud rate127
- J-G-B Parity, stop bits127
- J-G-C Minimum response time127
- J-G-D Transmitter warm-up time128
- J-G-E Flow control128
- J-G-F Sending window128
- J-G-G Receiving window128

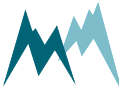

J-G-H	Trig, polling	128
J-G-I	Trig, timeout	129
J-G-J	Trig, sleep while timeout	129
J-G-K	Network scan extension	129
J-G-L	Polling delay	130
J-G-M	Transparency to RS485-2	130

J-G-A Baud rate

The following transmission rates in bps (baud) can be selected:

1'200
2'400
4'800
9'600 (default)
19'200
38'400
57'600
115'200

J-G-B Parity, stop bits

The following combinations of parity and stop bits can be selected:

Option	Description
no par, 1 stop (default)	No parity and 1 stop bit
no par, 2 stop	No parity and 2 stop bits
even par, 1 stop	Even parity and 1 stop bit
odd par, 1 stop	Odd parity and 1 stop bit

J-G-C Minimum response time

Setting of this parameter avoids interference of communication at the RS-485 interface. For this purpose the response to a command is delayed by the selected time. Additionally, the response is kept compact.

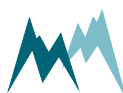

Unit	ms	Milliseconds
Value range	0...2'000	10 (default)

J-G-D Transmitter warm-up time

The transmitter warm-up time defines the time before data is sent.

Unit	ms	Milliseconds
Value range	0...2'000	10 (default)

J-G-E Flow control

The XOFF-XON flow control can be activated with this setting.

Option	Description
Off (default)	no flow control
XOFF-XON blocking	XOFF-XON flow control, especially adapted for half-duplex systems

J-G-F Sending window

If XON-XOFF flow control is activated data are transmitted in blocks with the defined length.

Unit	ms	Milliseconds
Value range	200...5'000	300 (default)

J-G-G Receiving window

If XON-XOFF flow control is activated transmission of blocks is delayed by the specified time.

J-G-H Trig, polling

Sets the polling of connected digital sensors.

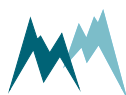

Setting	Description
off (default)	Continuous polling is inactive.
on	Continuous polling is active.

J-G-I Trig, timeout

The time the MRL-7 is waiting until expected commands/answers are received via the RS485-2 interface.

Unit	sec	Seconds
Value range	3 ... 250	60 (default)

J-G-J Trig, sleep while timeout

To reduce power consumption the MRL-7 can switch to a sleep mode between measurements.

Setting	Description
off (default)	MRL-7 remains activated between measurements, i.e. during Trig, timeout
on	MRL-7 is inactive between initialization of measurement and reception of measurement data. The connected sensor must send a Prefix command to wake up the MRL-7 for data transmission.

J-G-K Network scan extension

Optional detection of connected SOMMER sensors with the Commander software.

Setting	Description
off (default)	Detection of SOMMER devices connected to RS485-2 is deactivated.
on	Detection of SOMMER devices connected to RS485-2 is activated.



J-G-L Polling delay

Time by which polling of multiple digital sensors is delayed. Used to poll sensors in sequence to avoid communication conflicts.

Value range	Default	Unit
0 ... 20	2	sec

J-G-M Transparency to RS485-2

Only available in terminal mode. After activation, direct communication with a connected sensor is enabled, i.e. commands and their answers are exchanged over the RS485-2 interface of the MRL-7. With this mode the settings of a connected digital sensor can be read or changed.

J-H SDI-12 bus mastering

J-H-A	Max. measurement duration	130
J-H-B	Sensor search	130
J-H-C	Change sensor address	130
J-H-D	Ask for sensor address	131

J-H-A Max. measurement duration

The timeout for commands sent to SDI-12 devices connected to the MRL-7. If a SDI-12 device does not respond to a command within this time the device returns an error.

Unit	sec	Seconds
Value range	0 ... 255	20 (default)

J-H-B Sensor search

Searches for connected SDI-12 sensors and lists their identification and sensor address in the terminal window.

J-H-C Change sensor address

Changes the SDI-12 address of a connected sensor.

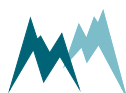

J-H-D Ask for sensor address

Reads the SDI-12 address and its identification of a single SDI-12 sensor connected to the MRL-7.

J-I Analog setup

J-I-A	5V sensor supply	131
J-I-B	12V sensor supply	131
J-I-C	Extended supply	132
J-I-D	Switch usage	132
J-I-E	Warm-up time	132
J-I-F	ADC - conv. Rate	132
J-I-G	ADC filter	133
J-I-H	AN3 (N) type	133
J-I-I	AN4 (D) type	134

J-I-A 5V sensor supply

Sets the 5V analog sensor supply (.).

Setting	Description
off (default)	5V sensor supply is inactive
switched	5V sensor supply is active during measurements only
always on	5V sensor supply is always on

J-I-B 12V sensor supply

Sets the 12V analog sensor supply.

Setting	Description
off (default)	12V sensor supply is switched off.
switched	12V sensor supply is active during measurements only (max. 200mA).
always on	12V sensor supply is always active (max. 200mA).

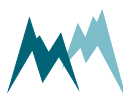

J-I-C Extended supply

Auxiliary voltage and current output for analog measurements. If one of the options is selected, [Warm-up time](#) applies.

Setting	Description
off (default)	Extended supply is inactive
2.5V	2.5V are supplied at the 2.5V Ref-Out pin
0.5mA	0.5mA are supplied at the CurrH pin
2.5V + 0.5mA	2.5V are supplied at the 2.5V Ref-Out pin and 0.5mA at the CurrH pin

J-I-D Switch usage

Activates switched 12-V supply ([SW](#)) for analog measurements.

Setting	Description
off (default)	Switched supply voltage is inactive.
1	SW1 is active during measurements.
2	SW2 is active during measurements.
3	SW3 is active during measurements.

J-I-E Warm-up time

The time required to return valid measurements, e.g., if an analog sensor requires warm-up to perform properly.

Value range	Default	Units
0...255	0	sec

J-I-F ADC - conv. Rate

The sampling rate of the analog inputs.

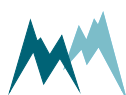

Setting	Description
2 Hz	Sampling rate of 2 Hz
3 Hz	Sampling rate of 3 Hz
5 Hz	Sampling rate of 5 Hz
8 Hz	Sampling rate of 8 Hz
25 Hz	Sampling rate of 25 Hz
62 Hz	Sampling rate of 62 Hz
125 Hz	Sampling rate of 125 Hz
250 Hz	Sampling rate of 250 Hz

J-I-G ADC filter

Filter for analog data acquisition.

Setting	Description
off (default)	Each analog channel is sampled once and no filter is applied.
minimum of 3	Each analog channel is sampled three times per measurement cycle and the minimum value is returned.
medium of 3	Each analog channel is sampled three times per measurement cycle and the median value is returned.
mean of 3	Each analog channel is sampled three times per measurement cycle and the mean value is returned.

J-I-H AN3 (N) type

Measurement type of analog input channel [AN3](#).



Setting	Description
voltage 2.5 (default)	Analog voltage input 0V ... 2.5V.
NTC	Measures the resistance of an NTC-thermistor.
R meas > 2k	Measures a resistance >2 kΩ.

J-I-I AN4 (D) type

Measurement type of analog input channel [AN4](#).

Setting	Description
voltage 2.5 (default)	Analog voltage input 0V ... 2.5V.
voltage 0.3	Analog voltage input 0V ... 0.3V.
R meas > 1k2	Measures a resistance >1.2 kΩ.
R meas < 1k2	Measures a resistance <1.2 kΩ.
PT1000	Measures the resistance of a PT1000 temperature sensor.

J-J Camera

J-J-A	Switch	134
J-J-B	Warm-up time	135
J-J-C	Solar nightshutdown	135
J-J-D	View	135

J-J-A Switch

Powering of a connected camera.



Setting	Description
off (default)	Camera is not powered by the MRL-7
1	Camera is connected to switched 12-V supply SW1.
2	Camera is connected to switched 12-V supply SW2.
3	Camera is connected to switched 12-V supply SW3.

J-J-B Warm-up time

The warm-up time of the camera. Only available if camera is powered by one of the switched 12-V supplies (SW).

Value range	Default	Unit
0 ... 120	30	sec

J-J-C Solar nightshutdown

Activation of camera during the night. Only applicable if MRL-7 is solar powered.

Setting	Description
off	Camera takes pictures during night and day.
on (default)	Camera does not take picture during the night.

J-J-D View

Function to acquire a picture. Activates the camera and displays the recorded JPEG-image in the Commander. The image is also stored in the default download location of the commander (generally `C:\Users\Public\Documents\Sommer\Data\`). If triggered with a terminal editor, the acquired image is displayed in its binary code.

K Special functions

K-A	Device status	136
K-B	View setup	136



K-C	Continuous meas. mode (temp).	136
K-D	Inspection, nominal values	136
K-E	Inspection, start process	136
K-F	Set factory default	136
K-G	Temp. load factory default	136
K-H	Relaunch program	137
K-I	Replace program	137

K-A Device status

Displays information about the sensor and the software version.

K-B View setup

All parameters of the MRL-7 are listed in the terminal window.

K-C Continuous meas. mode (temp).

Inactive in the Commander menu. This feature can be triggered under the [Measurement \(F3\)](#) tab with the command [Start polling measurements](#). When active, measurements are performed continuously, ignoring the specified measurement interval.

K-D Inspection, nominal values

Lists internal nominal values of the MRL-7 and is used for diagnostic purposes.

K-E Inspection, start process

Only for diagnostic purposes. Performs a test of the internally generated voltages and analog inputs.

K-F Set factory default

All parameters are reset to factory defaults. Only available in terminal-mode.

K-G Temp. load factory default

Loads factory default values temporarily. Only available in terminal mode.



K-H Relaunch program

The device is restarted. Powering the sensor off and on again is equivalent.

K-I Replace program

The sensor is set into a "Boot Loader" mode for three minutes to upload new software.

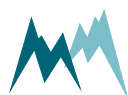

Appendix A Troubleshooting

A.1 Device is not powering up

Reason	Solution
Power supply not connected or off	Check if power supply is connected and on
Wrong polarity of connected power supply wires	Check polarity of connected wires
Internal 2A-fuse missing or blown	Replace/insert fuse (see How to replace the internal fuse)
Supply voltage out of range	Adjust power supply to permissible voltage; Check value of Internal low volt. Disconnect.

A.2 Data logger clock displays year 2050

Reason	Solution
Lithium button cell battery empty	Replace Lithium cell battery (see How to replace the internal lithium battery)

A.3 Measurement values are one hour behind

Reason	Solution
MRL-7 does NOT switch to daylight saving time, i.e. there is no time shift during clock change in spring and fall	Record data in default standard time, or adapt time manually



A.4 Commander does not find connected RS-485 sensors

Reason	Solution
Network scan extension off	Turn on Network scan extension
Sensor not connected or not powered	Verify sensor connection and power supply
Wrong polarity of RS-485 wires	Reverse polarity of RS-485 wires
Port settings do not match	Adapt port settings on sensor or in RS-485-2 Port

A.5 MRL-7 receives no data from RS-485 (SBP) sensors

Reason	Solution
Measurement trigger of sensor is set to SDI-12/RS485 , but Trig, polling of MRL-7 is set to <i>off</i>	Turn on Trig, polling
MRL-7 shall receive pushed data, but connected sensor is set to polling mode	Set measurement trigger of connected sensor to <i>interval</i>
Data from a digital sensor are returned after Trig, timeout has elapsed.	Increase Trig, timeout to max. measurement duration of the connected sensor plus a few seconds, or reduce any excess warm-up time of the sensor.
Wrong sensor number or measurement number in Measurement table	Verify sensor/measurement numbers in Measurement table

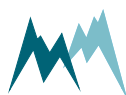

A.6 Commander cannot connect to the MRL-7 by IP call

Reason	Solution
Modem inactive	Activate modem in Modem functionality
SIM card not present or not activated	Insert activated SIM card
Wrong SIM pin or pin not deactivated	Check SIM pin , or deactivate SIM pin and enter -1 in SIM pin
Prepaid SIM card has run out of credit	Recharge prepaid SIM card
Station settings are incorrect	Check Station settings in the Commander Stations(F7) tab ; especially Station number , Sommer ID and IMSI number
Time window for logger access set inappropriately	Adjust Standby, start time and Standby, duration
No antenna connected	Connect antenna
Antenna connector damaged	Replace antenna connector
Lithium button cell battery has run out of power	Replace lithium button cell battery as described in How to replace the internal lithium battery

A.7 Data are not transmitted

Reason	Solution
No new data available for transmission	Check data storage interval
Data transmission interval set inappropriately	Adapt Data transmission interval
SIM card not present or not activated	Insert activated SIM card
Wrong SIM pin or pin not deactivated	Check SIM pin , or deactivate SIM pin and enter -1 in SIM pin
Prepaid SIM card has run out of credit	Recharge prepaid SIM card

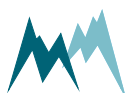

Reason	Solution
Modem inactive	Activate modem in Modem functionality
No antenna connected	Connect antenna
Antenna connector damaged	Replace antenna connector
Typo in APN configuration	Check APN address , APN username and APN password
Typo in FTP or HTTP server configuration	Check FTP and HTTP settings (e.g., <i>F</i> instead of <i>f</i> , <i>\</i> instead of <i>/</i>)
Mobile network provider only accepts SSL protocol	Add <code>at{smtcfg=1,587,1}</code> to Custom command 1 and change Port to <code>587</code>

A.8 No e-mail was sent upon limit violation

Reason	Solution
Message trigger not active	Activate the required message in Messages of Measurement table
Modem inactive	Activate modem in Modem functionality
SIM card not present or not activated	Insert activated SIM card
Wrong SIM pin or pin not deactivated	Check SIM pin , or deactivate SIM pin and enter <code>-1</code> in SIM pin
Prepaid SIM card has run out of credit	Recharge prepaid SIM card
No antenna connected	Connect antenna
Antenna connector damaged	Replace antenna connector
Typo in recipients email address	Check Recipient in Messages, table

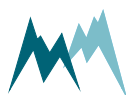

Reason	Solution
SMTP server settings are incorrect	Check settings in E-mail/SMTP
Mobile network provider only accepts SSL protocol	Add <code>at{smtpcfg=1,587,1}</code> to Custom command 1 and change Port to <code>587</code>
Lithium button cell battery has run out of power	Replace lithium button cell battery as described in How to replace the internal lithium battery

A.9 I receive repeated messages after limit violation

Reason	Solution
Min. Hold on message ≤ Storage interval	Increase Min. Hold on message
max. Hold on message not deactivated	Deactivate max. Hold on message by entering 0

A.10 Camera does not record images

Reason	Solution
Camera not powered	Verify that camera is powered
Warm-up time too short	Increase Warm-up time by several seconds
Wrong wiring of 12V power terminal X21	Reverse polarity of 12V power supply wires
Wrong polarity of RS-485 wires	Reverse polarity of RS-485 wires
Other digital sensors interfere with data communication	Check configuration of connected Sommer sensors; configure MRL-7 to poll data from sensors
Image viewer on PC does not open	Verify that an image viewer is installed on your PC
Third-party camera in use	Camera may require a different communication protocol. Contact Sommer Messtechnik for compatibility information.

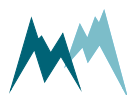

Appendix B Escape characters

The following escape characters may be used for parameter values where indicated:

Escape character	ASCII representation
\1	#
\2	;
\3	?
\4	
\r	<CR>
\n	<LF>
\t	<TAB>
\\	\

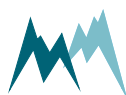

Appendix C DIP-switches

The counter inputs of the MRL-7 can be configured with three DIP-switches to receive different input signals. The location of the DIP-switches is shown in [Figure 1](#).





Figure 1 DIP-switches

To configure the counter inputs to receive signals from a sensor with either an open collector output or a source output, set the DIP-switches according to the following table:

DIP-switch	Position	Function
	 (Default)	Pin Wind-Dir on terminal X12 is configured as analog input to receive a wind direction signal (potentiometer), and pin Counter-2b on terminal X19 is deactivated.
SW322		Pin Counter-2b on terminal X19 is configured as counter input with a pull-up resistor (connects to a sensor with an open-collector output). Pin Wind-Dir on terminal X12 is deactivated.
		Pin Counter-2b on terminal X19 is configured as counter input with a pull-down resistor (connects to a sensor with an active output).
SW321	 (Default)	Pin Counter-2a on terminal X19 is configured as counter input with a pull-up resistor (connects to a sensor with an open-collector output).



DIP-switch	Position	Function
		Pin Counter-2a on terminal X19 is configured as counter input with a pull-down resistor (connects to a sensor with an active output).
SW320	 (Default)	Pin Counter-1 on terminal X10 is configured as counter input with a pull-up resistor (connects to a sensor with an open-collector output).
		Pin Counter-1 on terminal X10 is configured as counter input with a pull-down resistor (connects to a sensor with an active output).



Glossary

M

Modbus

A serial communications protocol for connecting industrial electronic devices.

P

Pull

A data acquisition device requests data from a sensor

Push

A sensor sends data to a data acquisition device automatically

R

RS-485

A standard defining the signal transmission in serial communication systems.

S

SDI-12

Asynchronous serial communications protocol for intelligent sensors (Serial Digital Interface at 1200 baud)

Single-ended

A voltage measurement referenced to ground



Index

R

RS-485 14, 18, 22, 26, 35, 74, 76-79, 90-91,
93, 102, 124, 126-127, 139, 142

S

SDI-12 13, 18, 22, 26, 35, 76-77, 94-95, 102,
124, 130-131, 139

